

FALCONTM

WORKBOOK/PRICE LIST January 2017

TRAINING, MEETING & CONFERENCE TABLES
PLUS POWER SOLUTIONS

**3.5%
increase***

*Effective September 1, 2018

ALL PRODUCTS NOTED WITH A RED 'X' HAVE BEEN DISCONTINUED FROM OUR STANDARD LINE AND ARE AVAILABLE ON A SPECIAL ORDER BASIS. MINIMUM ORDER QUANTITIES WILL APPLY.



FALCON™

WORKBOOK/PRICE LIST January 2017

ALL PRODUCTS NOTED WITH A RED 'X' HAVE BEEN DISCONTINUED FROM OUR STANDARD LINE AND ARE AVAILABLE ON A SPECIAL ORDER BASIS. MINIMUM ORDER QUANTITIES WILL APPLY.



Contents

3	The Falcon Advantage	40	Spectra Tables
4	How to Order	54	Storm Tables
5	Base and Table Finishes	79	Syntech Tables
6	Table Top Options	87	Symetris
7	Folio Tables	92	Conference Tables
17	Mats Tables	111	Power Solutions



Solid Cast Iron Base Construction



Drilled and Tapped Glides
J-Series Uses Fully Welded Construction

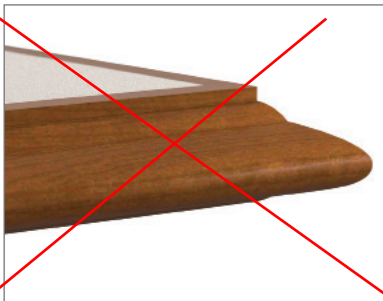

Mortise and Tenon Wood Edges

The Falcon Advantage

CAST IRON BASES: DURABLE AND ENVIRONMENTALLY SOUND

- Made from 98% recycled grey iron.
- Solid cast iron (not hollow), makes the base plates dent proof.
- Multiple glide options designed to meet all flooring requirements.
- Bases are drilled and tapped for glides. We do not use glide inserts which can easily break.
- J-Series steel bases offer fully welded construction; perfect for use in high abuse or extra heavy table tops such as stone.
- Proven track record of 51 years, the longest in the industry.

BASE FINISHES: STRONG, SAFE, AND BEAUTIFUL

- Environmentally responsible, blended epoxy and polyester based powdercoat.
- Unique phosphate washing system allows powdercoat to permanently adhere to base withstanding years of use.
- Heavy nickel undercoat is used before the plating process. This important step creates our high-quality finish..

TABLE TOPS: CRAFTSMANSHIP AND DESIGN

- 45lb high-density recycled engineered core provides durability.
- Use of phenolic backing sheet prevents delamination, warping, and surface deflection.
- Mortise and tenon wood edges are durable, while minimizing dirt grabbing gaps.
- High quality finish, consisting of one sealer and two conversion varnish top coats, creates a beautiful and durable matte finish.
- Turn your vision into reality™. We are able to manufacture any size or shape table with multiple non-standard material options.

HOW TO ORDER



1. Specify Quantity
2. Select Base Plus Edge Profile to equal Model Number
 Syntech starter table/no modesty with 23000 edge
 250CS plus edge profile number = 250CS-23000
3. Select Table Top Shape and Size
 - Standard shapes and sizes are included in each pricing grid
 - Find your starting table price by selecting your edge profile grade and your table shape and size.
4. Select Metal Base Finish
 - See available metal finishes on next page
 - All bases are standard Grade 3 Powdercoat
5. Select Table Top Material
 - All prices are Grade 1 Laminate. Optional laminate grades available, call for pricing.
 - Custom wood finishes also available, call for pricing.
 - Upcharge for Long Grain Maple or Oak Veneer:
 Order must specify species or maple is provided
6. Select Edge, Color, or Finish and Species
 - Wood Edge - Select wood finish and species.
 - Maple species is standard.
 - Oak is optional at same price and must be specified on order.
 - Other wood species are available. Please call for quote.
 - Vinyl, Urethane, PVC - Select Color Number and Name.
 - See available Edge Colors opposite and on falconproducts.com.
7. Specify Options
 - Specify Base Options
 - Specify Table Top Options
 - Specify Power if Applicable
8. F.O.B. Factory
 - Shipped unassembled
 - Welded bases shipped setup.
9. Freight
 - Zone 1, Included in list price. Zone 2, Add 4% to list price
10. Small Order Charge
 Orders with a combined Net price under \$1,000 will be subject to a Special Handling Charge of \$125 Net. One charge per order.

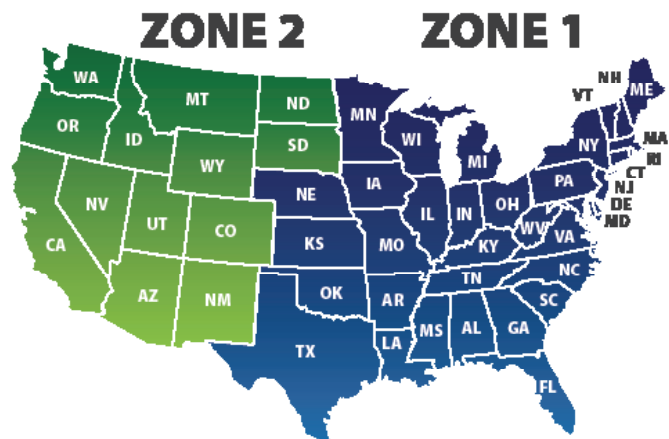

BASE AND TABLE FINISHES

METAL BASE FINISHES

	Polished
<u>Powdercoat Colors</u>	GRD 3
Absolute Black	T-13
Almond	CP010S
Architectural Bronze	AB-2
Black Wrinkle	R100
Bright White	T-12
Fog	CP012S
Gloss Black	CP001GS
GraphiteCP042S	
Grey Iron	N351
Gunmetal	T-14
Matte Black	CP001MS
Olympic Bronze	T-9
Silvertone	E-2
Storm	CP023S
Chrome	P-3
Satin Chrome	P-4

Note: Recessed areas in bases are not polished.

Note: Designer Finishes are not recommended for outdoor use.

WOOD BASE AND TABLE FINISHES

WBF Wood Finishes	
Natural	WBF110
Golden	WBF112
Medium Oak	WBF122
Chestnut	WBF124
Medium Brown Mahogany	WBF126
Dark Walnut	WBF128
Light Cherry	WBF131
Amber Cherry	WBF134
Royal Mahogany	WBF136
Black	WBF154

Note: Wood finishes will vary due to inconsistencies in lumber and moisture; therefore we assume no responsibility for matches to exact tones. When matching to laminate patterns containing large variations in color, stain will be matched with harmonizing tone

LAMINATE TABLE FINISHES

Listed below are our most popular laminates, which are available at standard pricing and lead times.

- Formica
- Solid Color Portfolio (Matte Finish)
- Patterns
- Formations Collection
- Woodgrains

If you would like to see an expanded offering, please visit Formica's web site at formica.com. You may also call Formica at 1-800-FORMICA for samples.

Should you require additional options, see selections at nevamar.com and wilsonartcontract.com. When you have made your selections, contact sales or customer service for pricing and lead time assistance. If the pricing or lead times are not to your satisfaction, we will be happy to help you reselect.

If your project requires something more unique, we can provide laminate from any manufacturer, including custom laminates. Please contact sales or customer service for assistance with pricing, lead times, and minimum order requirements.

CUSTOM FINISHES

Custom paint, metal, wood, or laminate finishes are always welcome. Falcon has the unique ability to custom tailor our products to fit your needs. Our manufacturing process is perfectly suited for custom finishes. Upcharges and additional lead time may apply. Please call Customer Service, 423-623-0031 for details.

EDGE COLORS

Almond	10
Bark	41
Black	1
Brown	2
Dark Grey	23
Dusk	P3
Graphite	42
Light Grey	12
Navy	14
Silver	50
White	949

Available on 13333 only	
Cherry	WG2
Mahogany	WG3
Natural Maple	WG1

Note: Not all edge series are available in every color. See Finishes, Edge Colors or Products, Table Tops on falconproducts.com for details.

EXTENDED WARRANTY
31CT/VT and 51CT/VT - 1 Year

All Other Tables - 5 Years

These terms are in addition to the Standard Warranty are available on www.falconproducts.com

TABLE TOP OPTIONS

T Mold



Feature	Benefit
T Mold Edge	Protects the top from incidental damage while being reconfigured or from chairs hitting against top
T Mold Edge	Stretched, pressure fit, and pinned for durability

Urethane



Feature	Benefit
Seamless Construction	Prevents moisture or bacteria from penetrating the edge
Soft Material	Forgiving when bumped against by other furniture items
Fused Material	Permanently molded into core

Wood



Feature	Benefit
Mortise and Tenon Construction	Insures years of beauty and durability and allows minimum waste
Solid Wood	Insures years of beauty and durability
Conversion Varnish Finish	Low emitting finish that is designed to hold up to the extreme demands of a dining facility
Edge on First Option	Value-priced, highly durable wood edge that is easy to clean

* Other species available upon request, order must specify

Veneer Art	
Add \$27 sq ft for Standard Veneer Art	
973 Euro Ash	981 Modern Makore
926 Canadian Maple	978 American Walnut
974 Brown Annigre	971 White Ash
913 Honey Annigre	976 Tropical Zebra wood
953 Renaissance Cherry	979 Bubinga
925 American Cherry	982 Architectural Sapele
921 Spanish Mahogany	980 Teak
920 Executive Mahogany	977 Bog Oak
Add \$49 sq ft for Bamboo	
972 Natural Bamboo	
975 Amber Bamboo	
• Veneer Art provides the beauty of real wood veneer with the durability of laminate.	

Table Top Features and Options

- Surface materials are standard with Grade 1 plastic laminate, but optional laminate grades, veneer, or Veneer Art are also available.
- Standard wood edge is Maple. Oak is optional at the same price. Other species are available upon request, order must specify.
- Veneer inlays are standard as long grain maple.
- Long grain oak available, order must specify
- Solid surface and Granite conference tables are available by special quote.

FALCON™

FOLIO™ TABLES

DROP ALL FOLIO PRODUCTS

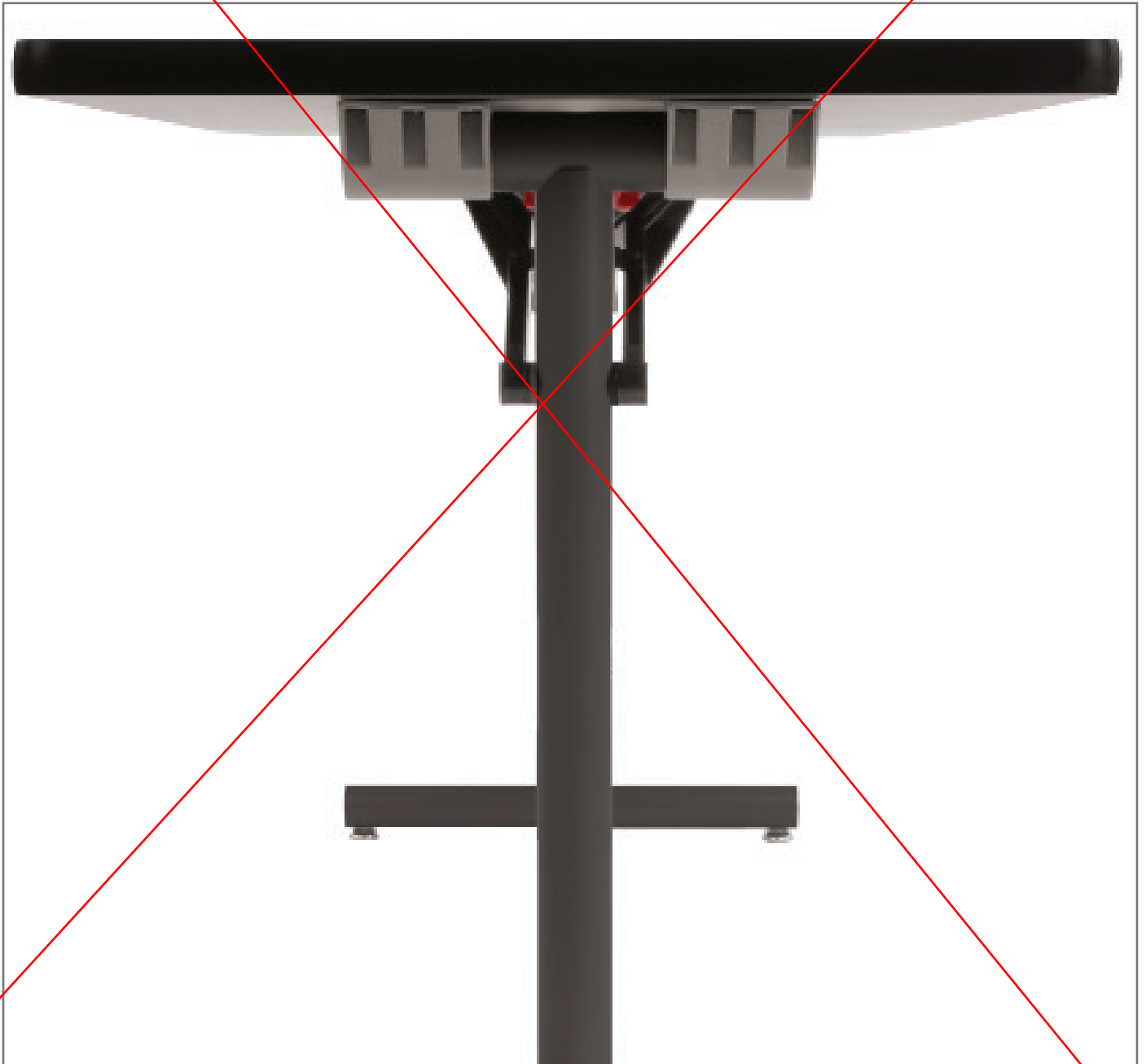

FOLDING

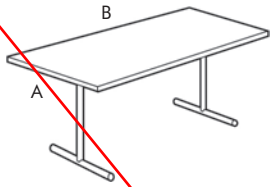

24FT RECTANGLE



Table Size A x B	Folding Leg Size	Apprx WT	1300	1333	2300	2400
18 x 60	15	89	972	982	1,172	1,323
18 x 72	15	98	982	993	1,200	1,377
18 x 84	15	107	1,107	1,122	1,296	1,609
18 x 96	15	116	1,113	1,130	1,310	1,637
24 x 60	20	106	997	1,009	1,175	1,455
24 x 72	20	118	1,113	1,130	1,310	1,637
24 x 84	20	130	1,248	1,269	1,465	1,986
24 x 96	20	142	1,254	1,281	1,636	2,051
30 x 60	24	122	1,083	1,098	1,219	1,476
30 x 72	24	137	1,133	1,156	1,390	1,659
30 x 84	24	152	1,289	1,318	1,590	2,003
30 x 96	24	167	1,312	1,338	1,672	2,062
36 x 60	24	139	1,116	1,134	1,362	1,740
36 x 72	24	157	1,244	1,267	1,472	1,828
36 x 84	24	175	1,475	1,507	1,856	2,316
36 x 96	24	193	1,480	1,514	1,884	2,375
42 x 72	32	188	1,655	1,685	2,041	2,522
42 x 84	32	209	1,783	1,820	2,245	2,819
42 x 96	32	230	1,801	1,844	2,282	2,875
42 x 108	32/3	276	2,620	2,669	3,186	3,880
42 x 120	32/3	296	2,647	2,697	3,233	3,949
48 x 72	38	207	1,671	1,706	2,072	2,567
48 x 84	38	231	1,783	1,820	2,245	2,819
48 x 96	38	255	1,801	1,843	2,282	2,875
48 x 108	38/3	317	2,647	2,697	3,233	3,949
48 x 120	38/3	341	2,676	2,728	3,281	4,019
48 x 144	38/3	389	2,872	2,937	3,596	4,482

• Tables above include 2 legs "/3" indicates 3 legs

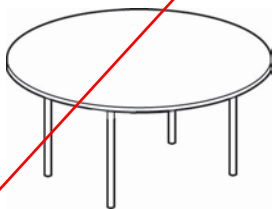

24FT ROUND



Table Size Diameter	Folding Leg Size	Apprx WT	1300	1333	2300	2400
54	1.75/4	180	2,041	2,070	2,642	2,937
60	1.75/4	190	2,071	2,103	2,674	2,969

• Tables above include 4 pin legs

NOTES

- Standard Grade 1 Laminate and any Grade 3 Powdercoat.
- Wood edges standard in Maple. Other species available, call for pricing.
- All prices are list delivered to Zone 1. Add 4% for Zone 2.
- Standard table height: 29"
- Shipped assembled.

FOLDING

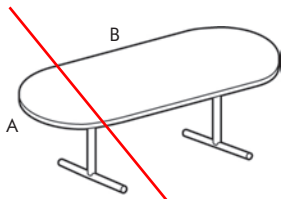

24FT RACETRACK



Table Size A x B	Folding Leg Size	Apprx WT	1300	1333	2300	2400
36 x 72	24	145	1,328	1,359	1,751	2,145
36 x 96	24	181	1,612	1,655	2,165	2,696
42 x 84	32	199	1,935	1,979	2,566	3,173
42 x 96	32	220	1,961	2,061	2,601	3,227
48 x 96	38	245	1,961	2,061	2,635	3,263
42 x 120	32/3	286	2,841	2,899	3,547	4,303
48 x 120	38/3	331	2,872	2,936	3,633	4,412

• Tables above include 2 legs *3" indicates 3 legs

LIGHTWEIGHT, FOLDING, 24FL SERIES

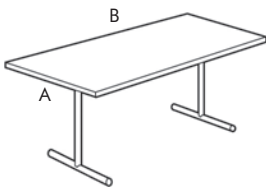

Table Size A x B	Folding Leg Size	Apprx WT	1308	1338	2308
18 x 60	15	65	1,107	1,116	1,310
18 x 72	15	72	1,116	1,130	1,335
24 x 60	20	76	1,122	1,134	1,306
24 x 72	20	80	1,248	1,265	1,447
30 x 60	24	82	1,133	1,157	1,348
30 x 72	24	90	1,268	1,287	1,523

• Tables above include 2 legs

24FA FOLDING MODESTY PANEL

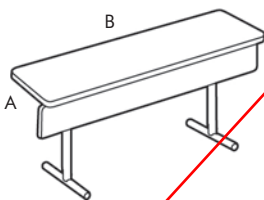
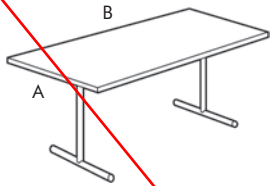

Table Size A x B	Folding Leg Size	Apprx WT	1300	2300	2400
18 x 60	15	109	1,269	1,555	1,704
18 x 72	15	124	1,311	1,614	1,795
18 x 96	15	148	1,502	1,792	2,117
24 x 60	20	126	1,345	1,538	1,820
24 x 72	20	144	1,504	1,730	2,055
24 x 96	20	174	1,726	2,116	2,529
30 x 60	24	142	1,365	1,649	1,839
30 x 72	24	163	1,550	1,805	2,075
30 x 96	24	199	1,787	2,152	2,543

• Tables above include 2 legs
• Modesty folds – not removable

STATIONARY



24TT RECTANGLE



Table Size A x B	Leg Size	Apprx WT	1300	1333	2300	2400	Veneer Upcharge
18 x 60	16	79	759	770	992	1,117	308
18 x 72	16	88	772	780	1,025	1,148	368
18 x 96	16	106	921	944	1,150	1,293	491
24 x 60	22	110	852	867	1,076	1,203	408
24 x 72	22	115	925	947	1,154	1,287	491
24 x 96	22	132	1,092	1,106	1,536	1,707	655
30 x 60	22	122	890	910	1,129	1,267	511
30 x 72	22	127	949	963	1,247	1,394	614
30 x 84	22	132	1,108	1,138	1,512	1,684	716
30 x 96	22	157	1,157	1,197	1,586	1,760	819

• Tables above include (2) 2400 Series end bases



24TT ROUND



Table Size Diameter	Leg Size	Apprx WT	1300	1333	2300	2400	Veneer Upcharge
30	22 x 22	57	554	562	849	959	257
36	28 x 28	75	572	710	1,192	1,347	368
42	28 x 28	90	850	870	1,282	1,461	502
48	36 x 36	125	1,094	1,115	1,559	1,802	655
60	36 x 36*	177	1,896	1,930	2,616	2,974	1,024

• Tables above include (1) 2400 Series pedestal base
* 5 column base for 60

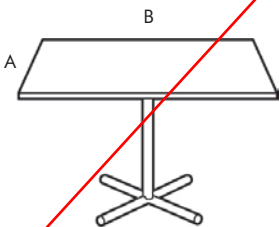

24TT SQUARE



Table Size A x B	Leg Size	Apprx WT	1300	1333	2300	2400	Veneer Upcharge
30 x 30	22 x 22	56	541	552	808	889	257
36 x 36	28 x 28	75	695	705	948	1,053	368
42 x 42	36 x 36	109	1,049	1,070	1,216	1,359	502
48 x 48	36 x 36*	136	1,603	1,625	1,806	2,019	655

• Tables above include (1) 2400 Series pedestal base
* 5 column base for 48 x 48

NOTES

- Standard Grade 1 Laminate and any Grade 3 Powdercoat.
- Wood edges standard in Maple. Other species available, call for pricing.
- All prices are list delivered to Zone 1. Add 4% for Zone 2.
- Standard table height: 29"
- Ships unassembled

STATIONARY

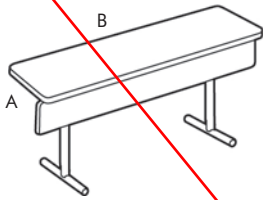

**24TM
FIXED MODESTY PANEL**



Table Size A x B	Leg Size	Apprx WT	1300	1333	2300	2400	Veneer Upcharge
18 x 60	16	109	1,092	1,104	1,428	1,642	511
18 x 72	16	124	1,140	1,148	1,499	1,726	614
18 x 96	16	148	1,362	1,381	1,704	1,958	778
24 x 60	22	126	1,184	1,203	1,511	1,737	614
24 x 72	22	144	1,292	1,313	1,633	1,877	736
24 x 96	22	174	1,531	1,559	2,089	2,402	942
30 x 60	22	142	1,225	1,243	1,563	1,797	716
30 x 72	22	163	1,318	1,534	1,728	1,988	860
30 x 96	22	199	1,598	1,627	2,137	2,456	1,104

• Tables above include (2) 2400 Series end bases

STATIONARY SHAPES

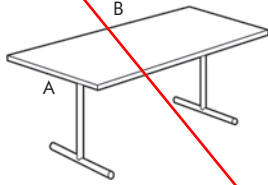

24TS RECTANGLE



Wood Edges Only

Table Size A x B	Leg Size	Apprx WT	1333	2300	2400	Veneer Upcharge
24 x 48	22	100	831	1,028	1,139	328
24 x 60	22	110	867	1,076	1,203	408
24 x 72	22	115	947	1,154	1,287	491
30 x 60	22	122	910	1,129	1,267	511
30 x 72	22	127	963	1,247	1,394	614
36 x 72	32*	150	1,133	1,477	1,643	736

- Tables above include (2) 2400 Series end bases
- 36 x 72 requires 2 columns

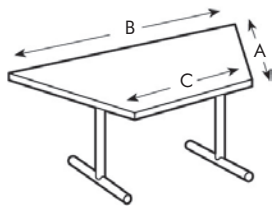

24TS TRAPEZOID



Wood Edges Only

Table Size A x B x C	Leg Size	Apprx WT	1333	2300	2400	Veneer Upcharge
24 x 48 x 24	16	100	958	1,188	1,319	328
30 x 60 x 30	22	122	1,082	1,361	1,527	511
36 x 72 x 36	22	150	1,238	1,618	1,800	736

- Tables above include (2) 2400 Series end bases

NOTES

- Standard Grade 1 Laminate and any Grade 3 Powdercoat.
- Wood edges standard in Maple. Other species available, call for pricing.
- All prices are list delivered to Zone 1. Add 4% for Zone 2.
- Standard table height: 29"
- Ships unassembled

STATIONARY SHAPES

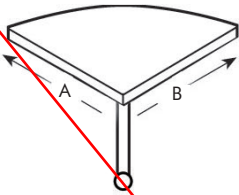

**24TS
QUARTER ROUND**



Table Size A x B	Leg Size	Apprx WT	1333	2300	2400	Veneer Upcharge
24 x 24	22 x 22	44	775	956	1,039	164
30 x 30	22 x 22	60	823	1,146	1,262	257
36 x 36	28 x 28	120	896	1,336	1,485	368

- Tables above include (1) 2400 Series end base
- Table must be ganged

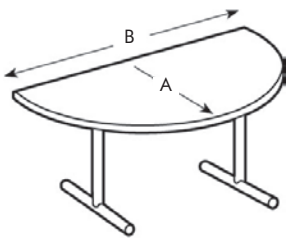

**24TS
HALF ROUND**



Table Size A x B	Leg Size	Apprx WT	1333	2300	2400	Veneer Upcharge
24 x 48	16	100	957	1,231	1,367	328
30 x 60	22	122	1,086	1,439	1,613	511
36 x 72	22	150	1,238	1,690	1,881	736

- Tables above include (2) 2400 Series end bases

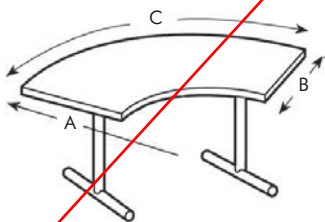

**24TS
CRESCENT**



Table Size A x B x C	Leg Size	Apprx WT	1333	2300	2400	Veneer Upcharge
48 x 24 x 75	16	120	1,288	1,697	1,953	1,227
60 x 24 x 94	16	140	1,588	2,364	2,717	1,842
48 x 30 x 75	22	130	1,322	1,736	1,998	1,227
60 x 30 x 94	22	154	1,645	2,441	2,808	1,800
48 x 36 x 75	32*	140	1,357	1,772	2,038	1,227
60 x 36 x 94	32*	165	1,704	2,502	2,877	1,800

- Tables above include (2) 2400 Series end bases
- * 48 x 36 x 75 and 60 x 36 x 94 require 2 (2400) end bases, each with 2 columns

SPECIFICATIONS

HOW TO ORDER

When ordering please specify:

1. Model Number & Edge Selection Number
2. Quantity
3. Shape
4. Size
5. Base Finish
6. Top Selection (laminare pattern number and description, veneer finish number and description)
7. Edge Finish Selection (specify wood finish and species if ordering wood edges)
8. Options
9. Small Order Charge
Orders with a combined Net price under \$1,000 will be subject to a Special Handling Charge of \$125 Net. One charge per order.

• For additional sizes and shapes, visit falconproducts.com

EDGE AND MODESTY PROFILES



1300 / 1308 Bumper T-Mold
1-1/4" laminate top. The edges are banded with solid vinyl "T" molding, with 3" radius at corners.
Modesty edge 1300



1333 / 1338 Eased T-Mold
1-1/4" laminate top. The edges are banded with solid vinyl "T" molding, with 1" radius at corners.
Modesty edge 1300



2300 / 2308 Wood Band
1-1/4" laminate top. The edges are banded with 1/4" hardwood. No radius at corners.
Modesty edge Flat Wood Band



2400 Wood Edge
1-1/4" laminate top. The edges are banded with hardwood. No radius at corners.
Modesty edge Flat Wood Band

STANDARD TABLE HEIGHT: 29"

TOP CONSTRUCTION

Substrate

High density 45 lb. core with backing sheet

Laminate

.050 thick high pressure plastic manufactured to N.E.M.A. standards, .045 thick phenolic resin sheet on underside.

Light Weight Top

Most light weight tops produced using light weight composite wood construction, specially designed to provide light weight rigidity. The core is 7/8" thick. Edges are built up to 1-1/4" using 1/4" fiberboard on perimeter of frame. Tops are balanced construction with plastic laminate or veneer surfaces and phenolic backer.

OPTIONS

GROMMETS



GRM2 - Grommet

- \$73
- Size: 1-3/4" Diameter
- Factory installed
- Standard location: 3" from back edge and 6" from right short edge
- Standard center location: 3" from back edge and center of table length.
- Black is standard

GANGING

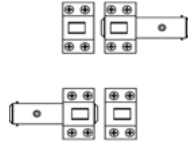

GA4 Ganging Device \$138

- Factory installed
- Specify ganging configuration, e.g. end to end, side to end, side to side, etc



WIRE MANAGEMENT

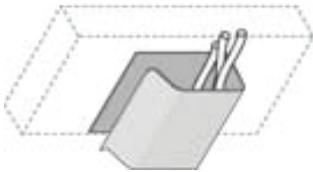

WM2 - Under Table Wireway \$91

- Up to 72" long table
- Black only

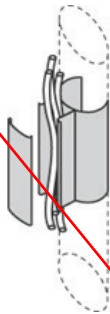

WM6B - Leg Wireway \$76

- Tables with 1-3/4 to 2" Diameter Columns
- Black only

MOBILITY



CS4 - Casters \$125 (set of 4)

- 2 locking and 2 non-locking per table
- Must be noted at time of order.
- Not available on pin legs
- Color: Black plastic.

HEIGHT ADJUSTABLE

NLU-36 - Lift Mechanism-Pedestal Base \$445

- Height of top will adjust 12"
- Maximum weight lift engaged 100 lbs
- Lift mechanisms are not gangable
- For 2400 series base only
- For 42" Square and Round Stationary Tables only

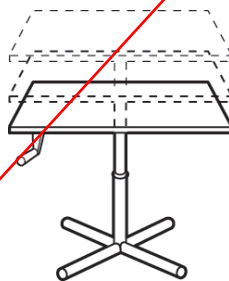

STORAGE TRUCKS

- Casters: 2 locking and 2 swivel
- Finish is CP001MS Matte Black with Grey carpeted bed.

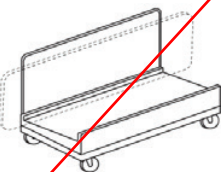

TT23042 Set Up Aid Tilt Truck- Rectangles

- \$1,557
- 80 lb
- 30" x 42"
- Maximum Capacity: 7 Tables

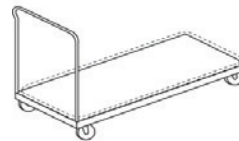

Flat Table Truck- Rectangles

- \$1,542
- 90 lb
- 30" x 96"
- Maximum Capacity: 10 Tables

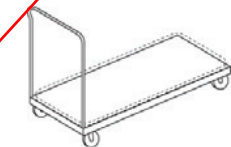

TT43072 Flat Table Truck- Rectangles

- \$1,529
- 80 lb
- 30" x 72"
- Maximum Capacity: 10 Tables

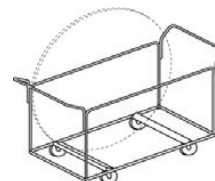

TT23060 Table Truck- Rounds

- \$1,672
- 95 lb
- 28.5" x 60"
- Maximum Capacity: 7 Tables
- Handles remove for easy folding

THIS PAGE DELIBERATELY BLANK

FALCON™

MATS™ TABLES

WORKBOOK/PRICE LIST January 2017

DELIVERED TO ZONE 1, ADD + 4% DELIVERED TO ZONE 2

ALL PRODUCTS NOTED WITH A RED 'X' HAVE BEEN DISCONTINUED FROM OUR STANDARD LINE AND ARE AVAILABLE ON A SPECIAL ORDER BASIS. MINIMUM ORDER QUANTITIES WILL APPLY.



FALCON™

MATS: MULTIPLE APPLICATION TABLE SYSTEMS

Contents

Portable

- 19 Lightweight Folding
- 21 Shapes and Configurations

Freestanding

- 22 Freestanding Stationary
- 24 Pedestal and Pin Leg Tables
- 25 Lift and Flip Options
- 26 Portable and Freestanding Table Options

Lecture

- 27 Lecture Hall

Shared Leg

- 28 Stationary Tables
- 30 Screen Groups
- 33 Modesty Panels and ADA Compliance

Custom Capabilities and Planner

- 34 Turn Your Vision Into Reality™
- 35 MATS Project Planner and Checklist

Ordering Information and Power Solution

- 36 Ordering Guidelines
- 37 MATS Power Solution

Edges and Colors

- 38 Edge Profiles, Colors and Laminates
- 38 Finishes

PORTABLE Lightweight Folding

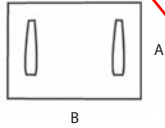

RECTANGLE



Table Size A x B	Apprx WT	Cantilever Leg	T-mold Vinyl 1357	Urethane 7157	Urethane 7167
24 x 42	58	20FC+	1,245	1,522	
24 x 48	62	20FC+	1,255	1,541	
24 x 60	72	20FC+	1,281	1,574	
24 x 72	78	20FC+	1,302	1,615	
30 x 42	62	20FC+	1,255	1,541	
30 x 48	68	20FC+	1,281	1,574	
30 x 60	78	20FC+	1,302	1,615	
30 x 72	86	20FC+	1,367	1,712	
36 x 60	86	N/A+	1,563	N/A	
36 x 72	94	N/A+	1,874	N/A	

- 4157 edge on one B side. Other sides are flat urethane (7167).
- + Available with symmetrical leg (20FS), same price.
- WM1 wire modesty gallery available on all cantilever tables, add \$394 each.
- WM1 wire modesty gallery available only on 30" and 36" symmetrical tables (20FS), add \$371 each.

LEG OPTIONS



Cantilever Leg
20FC



Symmetrical Leg
20FS

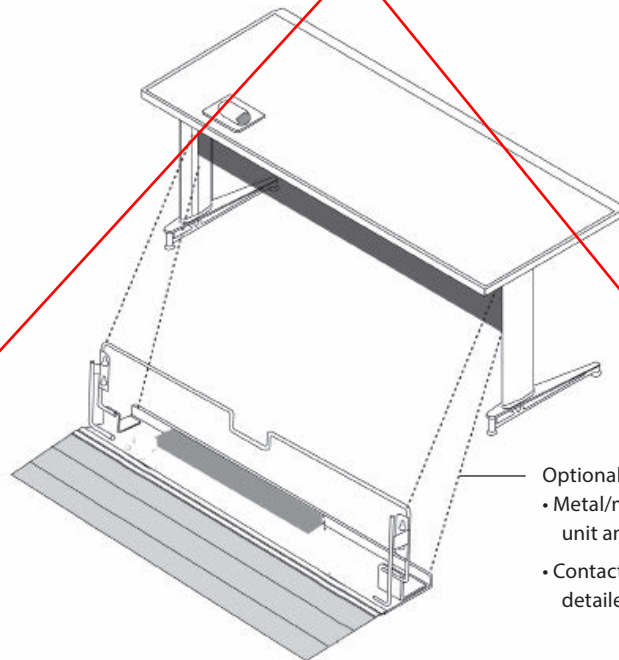

- Optional Removable Modesty Wire Gallery
- Metal/mesh housing that holds the power distribution unit and electrical/communication wires. (WM1).
 - Contact Sales or Customer Service for detailed electrical options.

PORTABLE Lightweight Folding

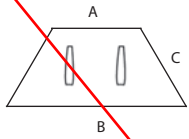

TRAPEZOID

Table Size A x B x C	Apprx WT	Symmetrical Leg	T-mold Vinyl 1357	Urethane 7167
30 x 60 x 30	60	20FS	1,541	1,770



• Symmetrical leg only.

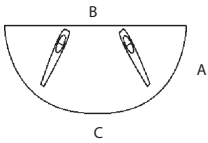

HALF ROUND

Table Size A x B x C	Apprx WT	Cantilever Leg	T-mold Vinyl 1357	Urethane 7157
25 x 50 x 78	52	20FC	1,514	1,731
31 x 62 x 97	67	20FC	1,619	1,885
24 x 48 x 75	50	20FC**	1,575	1,801



• 4157 edge on one C side. Other sides are flat urethane (7167).

• Cantilever leg only.

• **Allows for racetrack configuration w/o 2" center slot when ganged with rectangles.

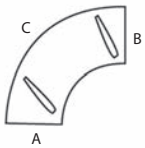

QUARTER CIRCLE CRESCENT

Table Size A x B x C	Apprx WT	Cantilever Leg	T-mold Vinyl 1357	Urethane 7157
36R x 24 x 56	52	20FC	1,514	1,731
48R x 24 x 75	65	20FC	1,619	1,885
48R x 30 x 75	70	20FC	1,665	1,944

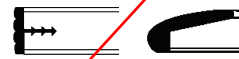

• 4157 edge on one C side. Other sides are flat urethane (7167).

• Cantilever leg only.

LEG OPTIONS



Cantilever Leg
20FC

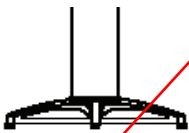

Symmetrical Leg
20FS

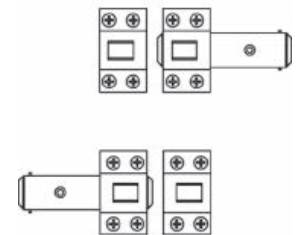
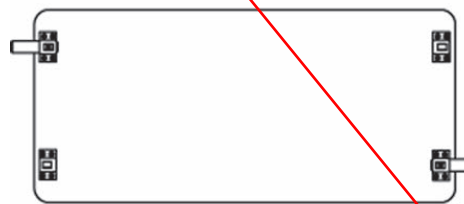

Ganging Device

All trapezoid, half round and quarter circle crescent tables include one set of gangers, which ship installed. Order additional ganging devices for the tables to be connected.

Drawing noting ganger placement required.

- NOTE**
- Wood edges standard in Maple. Other species available, call for quote.
 - WM1 wire modesty gallery not available.

PORTABLE Shapes and Configurations

SHAPES



Rectangle



Trapezoid



Half Round



Crescent



Quarter Round
Connector



30° Connector. Also available in:
15°, 45°, 60°, and straight

CONFIGURATIONS

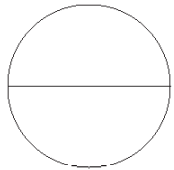

Round

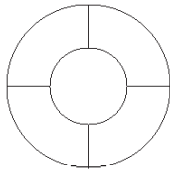

Circle

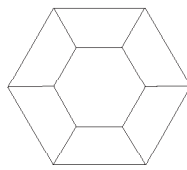

Hexagon-6

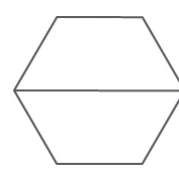

Hexagon-2

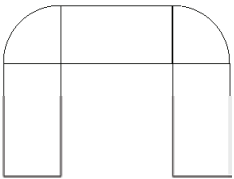

Horseshoe



Racetrack

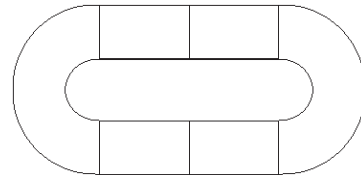

Open Racetrack

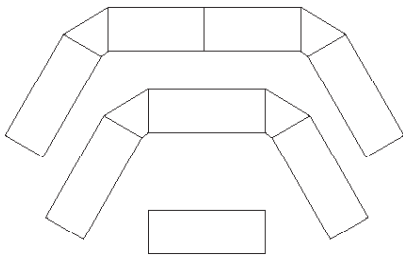

Classroom

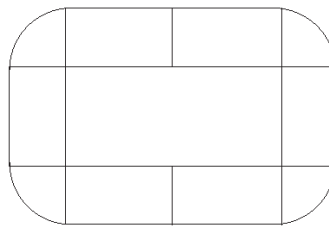

Enclosed U

FREESTANDING Stationary

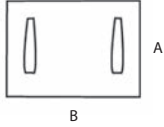
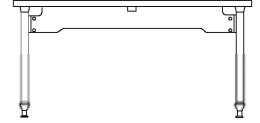

RECTANGLE



Table Size A x B	Apprx WT	Cantilever Leg	T-mold Vinyl 1350	Urethane 7150	Urethane 7160	Wood 2300
18 x 42	25	20TC	1,008	N/A		1,189
18 x 48	27	20TC	1,015	N/A		1,204
18 x 60	34	20TC	1,036	N/A		1,230
18 x 72	41	20TC	1,053	N/A		1,256
24 x 42	68	20TC	1,050	1,286		1,238
24 x 48	72	20TC	1,057	1,307		1,256
24 x 60	88	20TC	1,079	1,354		1,282
24 x 72	99	20TC	1,098	1,361		1,307
30 x 42	77	20TC ⁺	1,057	1,307		1,256
30 x 48	82	20TC ⁺	1,079	1,354		1,282
30 x 60	101	20TC ⁺	1,098	1,361		1,307
30 x 72	115	20TC ⁺	1,151	1,451		1,388

- 7150 edge on B side only. Other sides are flat urethane (7160).
- ⁺ Also available with symmetrical leg (20TS), same price.
- WM1 wire modesty gallery available, \$ 400 per table.

LEG OPTIONS



Cantilever Leg
20TC



Symmetrical Leg
20TS

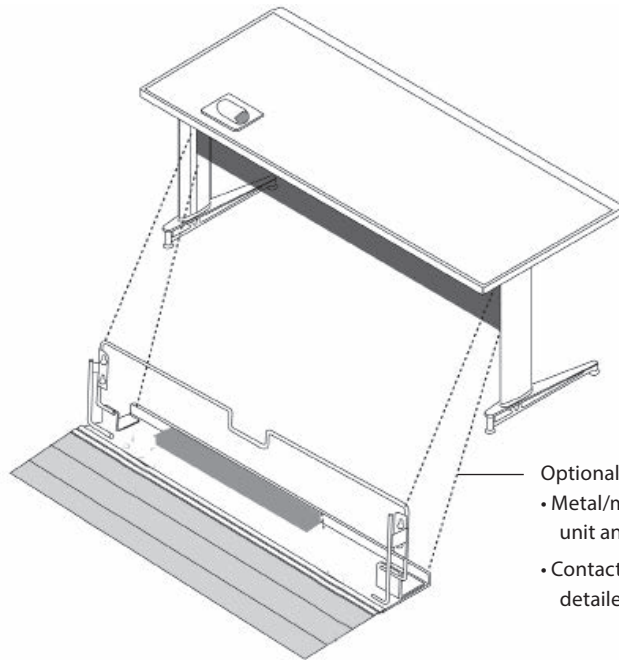

- Optional Removable Modesty Wire Gallery
- Metal/mesh housing that holds the power distribution unit and electrical/communication wires. (WM1).
- Contact Sales or Customer Service for detailed electrical options.

NOTE • Wood edges standard in Maple. Other species available, call for quote.

FREESTANDING Stationary

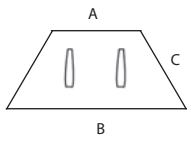

TRAPEZOID



Table Size A x B x C	Apprx WT	Symmetrical Leg	T-mold Vinyl 1350	Urethane 7160	Wood 2300
30 x 60 x 30	79	20TS	1,293	1,617	1,523

• Symmetrical leg only.

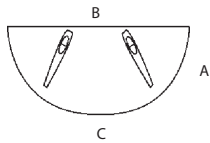

HALF ROUND

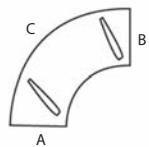

Table Size A x B x C	Apprx WT	Cantilever Leg	T-mold Vinyl 1350	Urethane 7150	Wood 2300
25 x 50 x 78	62	20TC	1,271	1,546	1,491
31 x 62 x 97	83	20TC	1,363	1,680	1,617
24 x 48 x 75	59	20TC**	1,412	1,605	1,551

• 4150 edge on C side only. Other sides are flat urethane (7160).

• Cantilever leg only.

• **Allows for racetrack configuration w/o 2" center slot when ganged with rectangles



QUARTER CIRCLE CRESCENT



Table Size A x B x C	Apprx WT	Cantilever Leg	T-mold Vinyl 1350	Urethane 7150	Wood 2300
36R x 24 x 56	61	20TC	1,271	1,546	1,491
48R x 24 x 75	77	20TC	1,363	1,680	1,617
48R x 30 x 75	87	20TC	1,400	1,732	1,623

• 7150 edge on C side only. Other sides are flat urethane (7160).

• Cantilever leg only.

LEG OPTIONS



Cantilever Leg
20TC



Symmetrical Leg
20TS

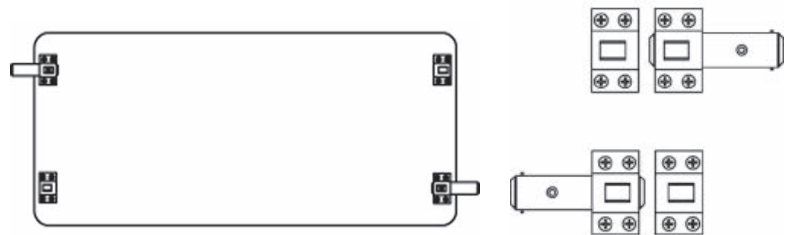

Ganging Device

All trapezoid, half round and quarter circle crescent tables include one set of gangers, which ship installed. Order additional ganging devices for the tables to be connected.

Drawing noting ganger placement required.

NOTE • Wood edges standard in Maple. Other species available, call for quote.
• WM1 wire modesty gallery not available

FREESTANDING Pedestal and Pin Leg

PEDESTAL BASE

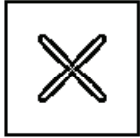

SQUARE

Table Size	Apprx WT	Model	T-mold Vinyl 1350	Urethane 7160	Wood 2300
36 x 36	64	20TX	6451	933	836
42 x 42	83	20TX	815	1,035	894



ROUND

Table Size	Apprx WT	Model	T-mold Vinyl 1350	Urethane 7160	Wood 2300
42Rd	70	20TX	823	1,213	1,101
48Rd	79	20TX	987	1,267	1,324

• △ 7150 edge also available, same price.

NOTE • Accent collar for Pedastak bases onyl avaloable in Black

PIN LEG BASE

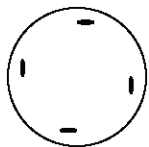

ROUND

Table Size	Apprx WT	Model	T-mold Vinyl 1350	Urethane 7160	Wood 2300
48Rd	104	20TP	1,257	1,588	1,601
60Rd	141	20TP	1,550	1,881	2,076

BASES

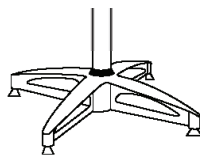

Pedestal Base





Pin Leg Base

• Wood edges standard in Maple. Other species available, call for quote.

FREESTANDING Lift Mechanisms & Flip Tops Options

MODEL	DESCRIPTION	PRICE
20TC2IL	<p>Manual/Incremental - Lift Mechanism</p> <ul style="list-style-type: none"> • Available on MATS fixed base rectangles. • Not available on pin leg tables or pedestal bases, folding legs, or tables with casters, or modesty panels. • Wire Manager does not move up with table top. • Incremental Manual Pin Adjustment - adjustable from 29" to 40" in 1" increments. • Maximum weight with lift mechanism engaged: 300lbs. • Left mechanism are not gangable. • Weight: 1 lb. 	701
FTD3	<p>Flip Top Mechanism</p> <ul style="list-style-type: none"> • Fixed Base Tables only - Pedestal Base. • For use with Falcon table tops only. • Maximum table tops for use: 42" square, 48" round, 30" x 48" rectangle. • 10 gauge steel. • Weight: 6 lbs. 	214

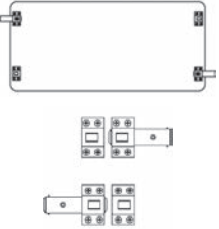
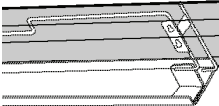
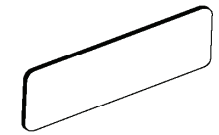
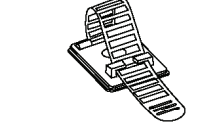
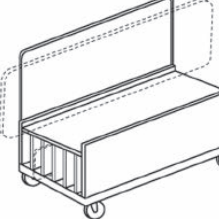
PORTABLE AND FREESTANDING OPTIONS

MODEL	DESCRIPTION	PRICE
 <p>The image shows a rectangular ganging device with four mounting points at the corners. Below it are two smaller diagrams showing the device being attached to a table edge.</p>	<p>GA2</p> <p>Ganging Device</p> <ul style="list-style-type: none"> • One set per top required, ships installed. • Include ganger placement drawing with your order 	157
 <p>The image shows a cross-section of a wire gallery being installed on a table edge. The gallery is a thin, rectangular metal strip with a wire mesh top.</p>	<p>WM1</p> <p>Wire Modesty Gallery</p> <ul style="list-style-type: none"> • Available on fixed and folding base tables. • Remove gallery before folding table • Color: Black • 7.089" High • Weight: 8lb (4kg) 	419
 <p>The image shows a simple rectangular panel with rounded corners, representing the upper modesty panel.</p>	<p>UG1</p> <p>Upper Modesty Panel with $\frac{3}{4}$" T-Mold Edge</p> <ul style="list-style-type: none"> • Removable clamp on attachment • Specify length of table • Weight: 12 lb (6kg) 	333
 <p>The image shows a small, adjustable metal clip with a spring mechanism, used for securing cables.</p>	<p>CC1</p> <p>Cable Clip - Adjustable</p> <ul style="list-style-type: none"> • Includes: 2 clips and 2 mounting screws 	27
 <p>The image shows a rectangular metal cart with four casters and a hinged lid, used for transporting and storing modesty panels.</p>	<p>TT203042</p> <p>Set Up Aid Tilt Truck - Rectangles</p> <ul style="list-style-type: none"> • Maximum Capacity: 5 Tables & 6 wire modesty galleries • Finish: CP001MS Matte Black • Carpet: Grey • Casters: 2 locking, 2 swivel • Size: 30" X 42" (76.2 cm X 106.7 cm) • Truck slots are designed to hold modesty panels • Weight: 140lb (64kg) 	2,929
 <p>The image shows a single castor wheel with a locking mechanism and a mounting stem.</p>	<p>CS5</p> <p>Casters (2 locking / 2 non-locking per table)</p> <ul style="list-style-type: none"> • Not for use with pin leg units or units with upper cabinets • Must be specified at the time of order • Leg is shortened to accommodate caster height • Set of 4 	147

LECTURE Features & Benefits



Attached Chair and Table Features



Access to data and power



Sturdy base for support



U.L. approved electrical system



Verona Seating by Falcon



Reva Seating by Thonet

Both seating units feature 360° Rotation -
Self Returning Swivel Seat and Swing Design

Attached Table Features



Perforated Steel Modesty



Contoured Steel Modesty

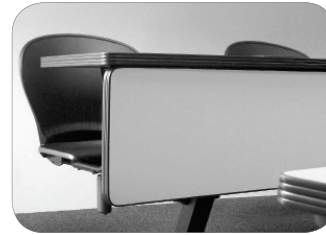

Laminated Modesty Panel

NOTE • Contact your sales representative for more information.

SHARED LEG 29" Height Basic Stationary Tables



41S - FREESTANDING/STARTER

Top Size	Apprx WT	Model	Laminate/ PVC 4720	Urethane 7150
24 x 30	69	41S29	1,101	1,238
24 x 36	76	41S29	1,147	1,290
24 x 42	82	41S29	1,213	1,307
24 x 48	88	41S29	1,262	1,376
24 x 54	100	41S29	1,348	1,555
24 x 60	106	41S29	1,395	1,618
24 x 72	122	41S29	1,540	1,792
30 x 30	77	41S29	1,125	1,265
30 x 36	84	41S29	1,177	1,327
30 x 42	92	41S29	1,247	1,402
30 x 48	99	41S29	1,299	1,468
30 x 54	112	41S29	1,391	1,590
30 x 60	119	41S29	1,440	1,652
30 x 72	138	41S29	1,596	1,831

- 4720 edge on user side only. Other sides are flat PVC.
- 7150 edge on user side only. Other sides are flat urethane (7160).

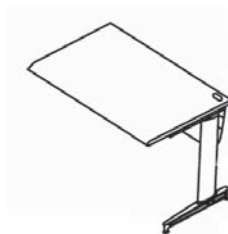

42A - ADD ON

Top Size	Apprx WT	Model	Laminate/ PVC 4720	Urethane 7150
24 x 30	56	42A29	871	1,009
24 x 36	63	42A29	917	1,061
24 x 42	69	42A29	982	1,147
24 x 48	75	42A29	1,034	1,198
24 x 54	87	42A29	1,116	1,327
24 x 60	93	42A29	1,168	1,390
24 x 72	109	42A29	1,313	1,563
30 x 30	63	42A29	899	1,036
30 x 36	71	42A29	948	1,101
30 x 42	78	42A29	1,018	1,177
30 x 48	85	42A29	1,071	1,241
30 x 54	98	42A29	1,166	1,361
30 x 60	106	42A29	1,213	1,424
30 x 72	124	42A29	1,366	1,600

- 4720 edge on user side only. Other sides are flat PVC.
- 7150 edge on user side only. Other sides are flat urethane (7160).

- Also available in 27" Keyboard height and 38" Stand up height, special quote needed
- Contact Customer Service or Sales for more information.

NOTE • Basic Table includes top, cantilever legs, technology support gallery, and one right hand grommet (up to 48"), two grommets, right and left (over 48").

SHARED LEG 29" Height Corner Stationary Table



41S - CORNER CHAMFER, FREESTANDING/STARTER

Top Size	Apprx WT	Model	Laminate/ PVC 4720	Urethane 7150
48 x 48 x 24 x 24	128	41S29	2,854	2,905



• 4720 edge on user side only. Other sides are flat PVC.

• 7150 edge on user side only. Other sides are flat urethane (7160).

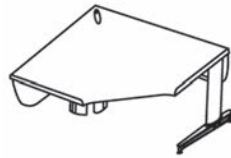

42A - CORNER CHAMFER, ADD ON

Top Size	Apprx WT	Model	Laminate/ PVC 4720	Urethane 7150
48 x 48 x 24 x 24	115	42A29	2,286	2,365

• 4720 edge on user side only. Other sides are flat PVC.

• 7150 edge on user side only. Other sides are flat urethane (7160).

- Also available in 27" Keyboard height and 38" Stand Up height.
- Contact Customer Service or Sales for more information.



Shared Leg Tables - 29" Height Basic Stationary Tables



Wire Management Gallery

NOTE • Basic Corner Table includes top, pin legs, and cantilever legs, technology support galleries, and one center grommet.

SCREEN GROUPS In-Line Screen Grouping



41LD - FREESTANDING/STARTER

Table Size	Screen Size	11" Height	17" Height
24 x 30	19 x 30	548	637
24 x 36	19 x 36		
24 x 42	19 x 42		
30 x 30	25 x 30		
30 x 36	25 x 36		
30 x 42	25 x 42		
24 x 48	19 x 48	583	684
24 x 54	19 x 54		
24 x 60	19 x 60		
30 x 48	25 x 48		
30 x 54	25 x 54		
30 x 60	25 x 60		
24 x 72	19 x 72	615	715
30 x 72	25 x 72		



42LD - ADD ON

Table Size	Screen Size	11" Height	17" Height
24 x 30	19 x 30	395	455
24 x 36	19 x 36		
24 x 42	19 x 42		
30 x 30	25 x 30		
30 x 36	25 x 36		
30 x 42	25 x 42		
24 x 48	19 x 48	429	503
24 x 54	19 x 54		
24 x 60	19 x 60		
30 x 48	25 x 48		
30 x 54	25 x 54		
30 x 60	25 x 60		
24 x 72	19 x 72	460	535
30 x 72	25 x 72		

- NOTE**
- Freestanding/Starter Screen Grouping includes:
 - Back Screen
 - Two Divider Screens
 - Brackets
 - Add On includes:
 - Back Screen
 - One divider screen
 - Hardware



In-Line Screen Grouping

SCREEN GROUPS Back-to-Back Screen Grouping

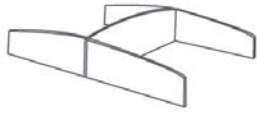

41BD - FREESTANDING/STARTER

Table Size	Screen Size	11" Height	17" Height
24 x 30	19 x 30	910	1,050
24 x 36	19 x 36		
24 x 42	19 x 42		
30 x 30	25 x 30		
30 x 36	25 x 36		
30 x 42	25 x 42		
24 x 48	19 x 48	947	1,098
24 x 54	19 x 54		
24 x 60	19 x 60		
30 x 48	25 x 48		
30 x 54	25 x 54		
30 x 60	25 x 60		
24 x 72	19 x 72	980	1,130
30 x 72	25 x 72		



42BD - ADD ON

Table Size	Screen Size	11" Height	17" Height
24 x 30	19 x 30	604	687
24 x 36	19 x 36		
24 x 42	19 x 42		
30 x 30	25 x 30		
30 x 36	25 x 36		
30 x 42	25 x 42		
24 x 48	19 x 48	641	736
24 x 54	19 x 54		
24 x 60	19 x 60		
30 x 48	25 x 48		
30 x 54	25 x 54		
30 x 60	25 x 60		
24 x 72	19 x 72	669	768
30 x 72	25 x 72		

- NOTE**
- Freestanding/Starter includes:
 - Back Screen
 - Four Divider Screens
 - Brackets
 - Add On includes:
 - Back Screen
 - Two Divider Screens
 - Hardware



Back-to-Back Screen Grouping

SCREEN GROUPS Corner Screen Grouping

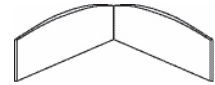

41LC - FREESTANDING/STARTER

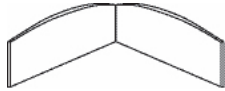

Table Size	Screen Size	11" Height	17" Height
24 x 48	48 x 48	463	538
30 x 48	48 x 48	463	538

42LC - ADD ON

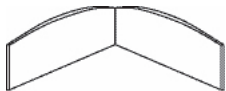

Table Size	Screen Size	11" Height	17" Height
24 x 48	48 x 48	463	538
30 x 48	48 x 48	463	538

SCREEN GROUPS Back-to-Back Corner Screen Grouping

41S - FREESTANDING/STARTER

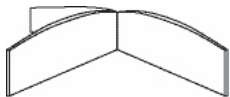

Table Size	Screen Size	11" Height	17" Height
24 x 48	48 x 48 x 48	709	821
30 x 48	48 x 48 x 48	709	821

42A - ADD ON

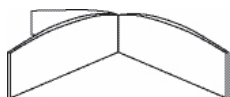

Table Size	Screen Size	11" Height	17" Height
24 x 48	48 x 48 x 48	709	821
30 x 48	48 x 48 x 48	709	821

- NOTE**
- Freestanding/Starter and Add On Corner Screen Grouping includes:
Two Back Screens
Brackets
 - Freestanding/Starter and Add On Back-to-Back Corner Screen Grouping includes:
Three Back Screens
Brackets
 - Corner screens are for use on 41S and 42A Corner Tables.



Corner Screen Grouping

STARTER & ADD ON MODESTY PANELS Lower Modesty Panels



FOR FREESTANDING UNITS

Table Widths	Catalog Number	Price
30, 36, 42	MODP2	256
48, 54, 60	MODP2	316
72	MODP2	331
Table width - Corner 48 (2 panels)	MODP2C	538



FOR STARTER & END OF RUN

Table Widths	Catalog Number	Price
30, 36, 42	MODPS	256
48, 54, 60	MODPS	316
72	MODPS	331
Table width - Corner 48 (2 panels)	MODPSC	538



FOR ADD ON UNITS

Table Width	Catalog Number	Price
30, 36, 42	MODPA	256
48, 54, 60	MODPA	316
72	MODPA	331
Table width - Corner 48 (2 panels)	MODPAC	538

ADA COMPLIANCE Wheelchair Adapter Kits

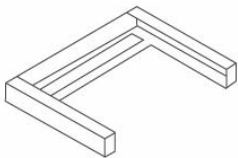

FOR 29" H TABLES

Catalog Number	WCK49 Price
WCK49	555

When ordering, note table length and width.
Only available on 30" deep tables.

NOTE • Wheel Chair Adapter Kit includes Black Laminate ADA Compliance Kit and attaching hardware.

• Lower Modesty Panel available in Matte Black laminate.



Lower Modesty Panel

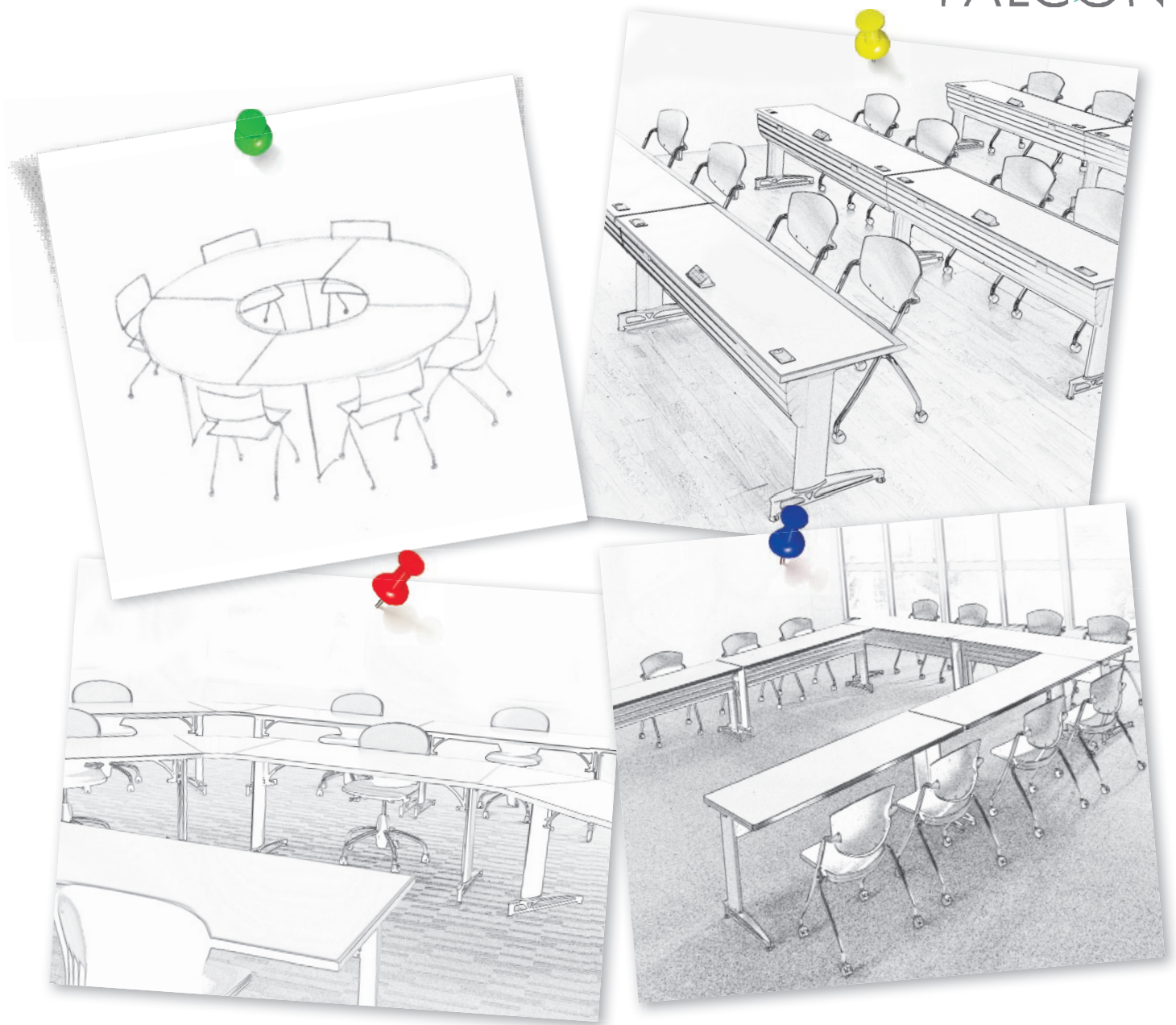

TURN YOUR VISION INTO REALITY™

If you don't see the product that you are looking for to fit a special space or design, don't panic. We offer total custom manufacturing capabilities.

We can work with almost any material, finish, and specification to fit any need. Send us a photograph, CAD drawing, or sketch and we will do everything possible to turn your vision into reality.

We offer full custom capabilities

- Training rooms, lecture halls, computer labs, testing stations, and classrooms
- Custom shapes and sizes to fit unique applications or ideas
- Speciality power solutions
- Built in or reconfigurable products
- Custom laminates and special finishes available

MATS PROJECT PLANNER AND CHECKLIST

We have found that the following information is key to helping you determine what product is best for your application needs, as well as helping to insure the smoothest possible on-time delivery and installation of your project. We have provided the following tool to assist you in your project planning.

	Name/Address	Phone	Email	Fax	Comments
Step One Document and share key contact information with all parties at the earliest possible stage and keep it updated.					
1. Dealer Contacts					
Sales Manager	<input type="checkbox"/> Y <input type="checkbox"/> N <input type="checkbox"/> TBD	<input type="checkbox"/> Y <input type="checkbox"/> N <input type="checkbox"/> TBD	<input type="checkbox"/> Y <input type="checkbox"/> N <input type="checkbox"/> TBD	<input type="checkbox"/> Y <input type="checkbox"/> N <input type="checkbox"/> TBD	_____
Sales Representative	<input type="checkbox"/> Y <input type="checkbox"/> N <input type="checkbox"/> TBD	<input type="checkbox"/> Y <input type="checkbox"/> N <input type="checkbox"/> TBD	<input type="checkbox"/> Y <input type="checkbox"/> N <input type="checkbox"/> TBD	<input type="checkbox"/> Y <input type="checkbox"/> N <input type="checkbox"/> TBD	_____
Accounts Payable	<input type="checkbox"/> Y <input type="checkbox"/> N <input type="checkbox"/> TBD	<input type="checkbox"/> Y <input type="checkbox"/> N <input type="checkbox"/> TBD	<input type="checkbox"/> Y <input type="checkbox"/> N <input type="checkbox"/> TBD	<input type="checkbox"/> Y <input type="checkbox"/> N <input type="checkbox"/> TBD	_____
Logistics/Install Manager	<input type="checkbox"/> Y <input type="checkbox"/> N <input type="checkbox"/> TBD	<input type="checkbox"/> Y <input type="checkbox"/> N <input type="checkbox"/> TBD	<input type="checkbox"/> Y <input type="checkbox"/> N <input type="checkbox"/> TBD	<input type="checkbox"/> Y <input type="checkbox"/> N <input type="checkbox"/> TBD	_____
2. Designer Contact					
	<input type="checkbox"/> Y <input type="checkbox"/> N <input type="checkbox"/> TBD	<input type="checkbox"/> Y <input type="checkbox"/> N <input type="checkbox"/> TBD	<input type="checkbox"/> Y <input type="checkbox"/> N <input type="checkbox"/> TBD	<input type="checkbox"/> Y <input type="checkbox"/> N <input type="checkbox"/> TBD	_____
3. COM Vendor contact					
	<input type="checkbox"/> Y <input type="checkbox"/> N <input type="checkbox"/> TBD	<input type="checkbox"/> Y <input type="checkbox"/> N <input type="checkbox"/> TBD	<input type="checkbox"/> Y <input type="checkbox"/> N <input type="checkbox"/> TBD	<input type="checkbox"/> Y <input type="checkbox"/> N <input type="checkbox"/> TBD	_____
4. Manufacturer's Project Coordinator					
	<input type="checkbox"/> Y <input type="checkbox"/> N <input type="checkbox"/> TBD	<input type="checkbox"/> Y <input type="checkbox"/> N <input type="checkbox"/> TBD	<input type="checkbox"/> Y <input type="checkbox"/> N <input type="checkbox"/> TBD	<input type="checkbox"/> Y <input type="checkbox"/> N <input type="checkbox"/> TBD	_____
5. Facility Manager or Site Representative					
	<input type="checkbox"/> Y <input type="checkbox"/> N <input type="checkbox"/> TBD	<input type="checkbox"/> Y <input type="checkbox"/> N <input type="checkbox"/> TBD	<input type="checkbox"/> Y <input type="checkbox"/> N <input type="checkbox"/> TBD	<input type="checkbox"/> Y <input type="checkbox"/> N <input type="checkbox"/> TBD	_____
6. Facility Address					
	<input type="checkbox"/> Y <input type="checkbox"/> N <input type="checkbox"/> TBD	<input type="checkbox"/> Y <input type="checkbox"/> N <input type="checkbox"/> TBD	<input type="checkbox"/> Y <input type="checkbox"/> N <input type="checkbox"/> TBD	<input type="checkbox"/> Y <input type="checkbox"/> N <input type="checkbox"/> TBD	_____

Name/Address	Comments	Name/Address	Comments
Step Two Define user needs			
1. Identified number of users per room?	<input type="checkbox"/> Y <input type="checkbox"/> N <input type="checkbox"/> TBD _____	1. New construction or existing?	<input type="checkbox"/> Y <input type="checkbox"/> N <input type="checkbox"/> TBD _____
2. Identified number of users per table?	<input type="checkbox"/> Y <input type="checkbox"/> N <input type="checkbox"/> TBD _____	2. Do we need a floor plan?	<input type="checkbox"/> Y <input type="checkbox"/> N <input type="checkbox"/> TBD _____
3. What functions do users need and what are they denied?		3. Do we have the key information for space access?	
Power	<input type="checkbox"/> Y <input type="checkbox"/> N <input type="checkbox"/> TBD _____	Doorway Dimensions	<input type="checkbox"/> Y <input type="checkbox"/> N <input type="checkbox"/> TBD _____
Data	<input type="checkbox"/> Y <input type="checkbox"/> N <input type="checkbox"/> TBD _____	Corridor Dimensions	<input type="checkbox"/> Y <input type="checkbox"/> N <input type="checkbox"/> TBD _____
Mobility	<input type="checkbox"/> Y <input type="checkbox"/> N <input type="checkbox"/> TBD _____	Loading Docks/Height	<input type="checkbox"/> Y <input type="checkbox"/> N <input type="checkbox"/> TBD _____
Access	<input type="checkbox"/> Y <input type="checkbox"/> N <input type="checkbox"/> TBD _____	Freight Elevators/Size/Restrictions	<input type="checkbox"/> Y <input type="checkbox"/> N <input type="checkbox"/> TBD _____
Change of use	<input type="checkbox"/> Y <input type="checkbox"/> N <input type="checkbox"/> TBD _____	Hours Available for Install	<input type="checkbox"/> Y <input type="checkbox"/> N <input type="checkbox"/> TBD _____
ADA	<input type="checkbox"/> Y <input type="checkbox"/> N <input type="checkbox"/> TBD _____	4. Will the space need to be reconfigurable?	<input type="checkbox"/> Y <input type="checkbox"/> N <input type="checkbox"/> TBD _____
Privacy	<input type="checkbox"/> Y <input type="checkbox"/> N <input type="checkbox"/> TBD _____	5. What is primary use for the space?	<input type="checkbox"/> Y <input type="checkbox"/> N <input type="checkbox"/> TBD _____
		6. Are casters required?	<input type="checkbox"/> Y <input type="checkbox"/> N <input type="checkbox"/> TBD _____
		7. Is there a need for carts?	<input type="checkbox"/> Y <input type="checkbox"/> N <input type="checkbox"/> TBD _____
		8. Is there a room configuration layout?	<input type="checkbox"/> Y <input type="checkbox"/> N <input type="checkbox"/> TBD _____
		9. Are drawings/plans current and approved?	<input type="checkbox"/> Y <input type="checkbox"/> N <input type="checkbox"/> TBD _____

Step Four Details for Product Specifications				Step Five Checkstep			
1. Table Tops				1. Does the product specification meet with the needs of the end users as specified above and if not, is the client aware of this?			
Shapes/Dimensions	<input type="checkbox"/> Y <input type="checkbox"/> N <input type="checkbox"/> TBD _____			<input type="checkbox"/> Y <input type="checkbox"/> N <input type="checkbox"/> TBD	_____		
Quantity	<input type="checkbox"/> Y <input type="checkbox"/> N <input type="checkbox"/> TBD _____			2. Have you reviewed Falcon's complementary seating products for these tables, such as Verona or Sienna?			
Top Surface Material	<input type="checkbox"/> Y <input type="checkbox"/> N <input type="checkbox"/> TBD _____			<input type="checkbox"/> Y <input type="checkbox"/> N <input type="checkbox"/> TBD	_____		
Edge Material	<input type="checkbox"/> Y <input type="checkbox"/> N <input type="checkbox"/> TBD _____			3. Do we have final sign off on specifications and are all of the key elements in place for			
Edge Profile	<input type="checkbox"/> Y <input type="checkbox"/> N <input type="checkbox"/> TBD _____			A successful installation	<input type="checkbox"/> Y <input type="checkbox"/> N <input type="checkbox"/> TBD _____		
Gangers/Placement Drawing	<input type="checkbox"/> Y <input type="checkbox"/> N <input type="checkbox"/> TBD _____			Credit approved or deposit received	<input type="checkbox"/> Y <input type="checkbox"/> N <input type="checkbox"/> TBD _____		
Connectors	<input type="checkbox"/> Y <input type="checkbox"/> N <input type="checkbox"/> TBD _____			COM ship to address provided to vendor	<input type="checkbox"/> Y <input type="checkbox"/> N <input type="checkbox"/> TBD _____		
2. Bases (Columns And Feet)				COM materials received from vendor	<input type="checkbox"/> Y <input type="checkbox"/> N <input type="checkbox"/> TBD _____		
Style	<input type="checkbox"/> Y <input type="checkbox"/> N <input type="checkbox"/> TBD _____			Order acknowledgement been reviewed for accuracy	<input type="checkbox"/> Y <input type="checkbox"/> N <input type="checkbox"/> TBD _____		
Are they appropriate for selected tops?	<input type="checkbox"/> Y <input type="checkbox"/> N <input type="checkbox"/> TBD _____			Pricing confirmed	<input type="checkbox"/> Y <input type="checkbox"/> N <input type="checkbox"/> TBD _____		
Finishes	<input type="checkbox"/> Y <input type="checkbox"/> N <input type="checkbox"/> TBD _____			Terms agreed upon	<input type="checkbox"/> Y <input type="checkbox"/> N <input type="checkbox"/> TBD _____		
Collar Color	<input type="checkbox"/> Y <input type="checkbox"/> N <input type="checkbox"/> TBD _____			Step Six Dates			
Any Weight Issues	<input type="checkbox"/> Y <input type="checkbox"/> N <input type="checkbox"/> TBD _____			1. Identify target delivery date	<input type="checkbox"/> Y <input type="checkbox"/> N <input type="checkbox"/> TBD _____		
ADA Requirements	<input type="checkbox"/> Y <input type="checkbox"/> N <input type="checkbox"/> TBD _____			2. Identify target installation date	<input type="checkbox"/> Y <input type="checkbox"/> N <input type="checkbox"/> TBD _____		
3. Lower Modesty Panels and Privacy Screens				3. Identify target completion date	<input type="checkbox"/> Y <input type="checkbox"/> N <input type="checkbox"/> TBD _____		
Dimensions	<input type="checkbox"/> Y <input type="checkbox"/> N <input type="checkbox"/> TBD _____						
Materials	<input type="checkbox"/> Y <input type="checkbox"/> N <input type="checkbox"/> TBD _____						
Edge Color	<input type="checkbox"/> Y <input type="checkbox"/> N <input type="checkbox"/> TBD _____						
4. Power And Data Requirements - See ordering and power in this workbook, contact your sales representative or customer service for detailed assistance							
5. Other Options							
Casters	<input type="checkbox"/> Y <input type="checkbox"/> N <input type="checkbox"/> TBD _____						
Table Trucks	<input type="checkbox"/> Y <input type="checkbox"/> N <input type="checkbox"/> TBD _____						
Optional Wire Galleries	<input type="checkbox"/> Y <input type="checkbox"/> N <input type="checkbox"/> TBD _____						
6. Are there any unusual requirements which may delay the project? Is the client aware of this potential?							
	<input type="checkbox"/> Y <input type="checkbox"/> N <input type="checkbox"/> TBD _____						

ORDERING INFORMATION

Visit falconproducts.com for Terms and Conditions.

SPECIFY THE FOLLOWING	PORTABLE TABLES - FOLDING (20FC/20FS)	FREESTANDING TABLES (20TC/20TS)	SHARED LEG TABLES (41S/42A)	SCREEN GROUPS
Standard Features				
Quantity	•	•	•	•
Catalog Number	•	•	•	•
Dimensions: Length, Width, Height (if applicable)	•	•	•	•
Edge Color/Finish	•	•	•	•
Wood Edge Species*		•		
Laminate **	•	•	•	•
Metal Finish	•	•	•	
Accent Collar Color	•	•	•	
Optional Accessories				
WM1 Wire Modesty Gallery	•	•		
Electrical	•	•	•	
Lift Mechanism		•		
Adjustable Height Option		•		
Connectors	•	•		
Gangers - Include Placement Drawings	•	•		
Upper Modesty Panel	•	•		
Cable Clip	•	•	•	
Tilt Truck	•			
Casters	•	•		
Grommets	•	•		

*Wood edges standard in Maple. Other species available, call for quote.

**Laminate: Manufacturer, pattern, color and number

All Products FOB: Newport, TN

Small Order Charge

Orders with a combined Net price under \$1,035 will be subject to a Special Handling Charge of \$129 Net. One charge per order.

NOTE • Please see back cover for complementary seating products.

MATS POWER SOLUTIONS

DEFINE YOUR APPLICATION

We have a variety of power solutions appropriate for any of your power requirements. Please take a moment to evaluate your project and complete the following check list. It will help determine which power solution best fits your needs. After you have answered these questions, contact your sales representative, or customer service representative, who will assist you with the specific details for adding the power option to your table order.

My client is powering more than one table (Y/N)

- _____ Our plan calls for less than 16 users per row
- _____ I need data brought into the tables
- _____ I need power at the top surface
- _____ I need power accessible below the table for CPU's to plug into
- _____ The room is permanent and will not be reconfigured
- _____ The room will have bolt down tables
- _____ Power is currently available in the wall
- _____ Power is currently available in the floor
- _____ New construction, power can be located anywhere
- _____ What is the desired table length
- _____ How many users per table

What will be plugged into each table:

- _____ Number of Computers
- _____ Number of Monitors
- _____ Number of Printers or other equipment
- _____ Does the building have 15 amp power available (Y/N)
- _____ Does the building have 20 amp power available (Y/N)

SOLUTIONS

I. Simple Power

Simple power is defined as a 15 amp plug that is inserted into a standard outlet. Each electrical component in the table would plug directly into the floor or wall. This power is commonly used with conference tables or very small training rooms.

II. Table Top Daisy Chain Power

This power allows you run rows of tables in a training room. Up to 16 users can generally be provided with power from one access point. If there are more than 16 users, additional access points must be designated. The type of power can be applied using one of the following options.

- a. Interlink:
 - i. 12 amp system rating with 15 amp power cord.
 - ii. Up to 8 duplexes devices such as Miniports.
 - iii. Meets UL 962.

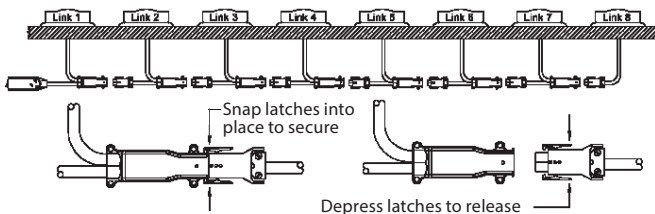

- b. Interconnect:
 - i. 8 wire, 4-circuit system or 4 wire 2 circuit system depending on power need.
 - ii. 20 amp system rating.
 - iii. UL 183.
 - iv. Must be hard wired to the building or utilize quick connect.
 - v. Building must be wired for 20 amp rating.



III. Fully Integrated Power within the Wire Manager and Table Top

This solution allows for computer rooms to power a CPU, monitor, printer, etc. from underneath the table surface as well as power other ancillary equipment from the top surface. It allows for long runs of power with the ability to segregate for clean circuits.

- i. 20 amp single circuit solution that utilizes a 20 amp plug.
- ii. 2 circuit system that is rated at 20 amps per circuit or a total of 40 amps which requires hardwiring to the building.
- iii. 4 circuit system that is rated at 20 amps per circuit or a total of 80 amps which requires hardwiring to the building.
- iv. UL1286 rated.
- v. Building must be wired for 20 amp rating.



Information is for planning purpose only. Contact a licensed electrician to ensure required building codes are met.

EDGES AND COLORS Table Edges and Laminates

EDGE PROFILES



- 4720**
- Clean sloped post form laminate edge
 - 1 1/4" thick top
 - Sloped edge on user side, other three edges flat PVC
 - Flat edges allow tables to be ganged
 - Perfect for high use applications
 - Wide variety of standard laminate options
 - Special laminates also available
 - Suitable for use with divider screens



- 4150/7157**
- Urethane sloped edge (user side)
 - 2 1/2" X 1 1/4"
 - 7160/7167 flat urethane edge on other three sides
 - Flat sides allow tables to be ganged
 - Extremely durable edge for high use applications
 - Suitable for use with divider screens
 - Five standard color options
 - Variety of additional color options available



- 7160/7167**
- Flat urethane edge
 - 1/4" X 1 1/4"
 - Extremely durable
 - Flat edge allows tables to be ganged
 - Variety of additional color options available

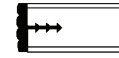

- 1350**
- Vinyl T mold
 - 1/4" X 1 1/4"
 - Decorative ribbed profile
 - Low cost alternative
 - Flat profile allows tables to be ganged
 - Variety of additional color options available

MOST POPULAR EDGE COLORS

Color Name	Code
Bark	41
Black	1
Dark Grey	23
Graphite	42
Light Grey	12

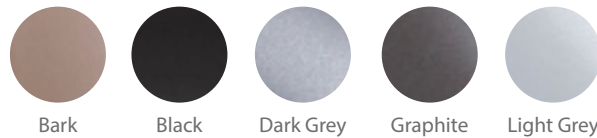

To view all available colors for each edge, visit falconproducts.com

4720 POSTFORM LAMINATE TOPS

Laminate - Grade 1 (standard)
Normal Lead Times

The following laminates are available for 4720 Postform tops in standard lead time. For lead times on additional laminate choices, contact sales or customer service, 423-623-0031.

Formica	
FO515	Graphite Grafix
FO912	Storm
FO503	Stone Grafix
FO961	Fog
FO507	Folkstone Grafix
FO920	Almond
FO5904	Wild Cherry
FO756	Natural Maple

TABLE SURFACE LAMINATE

Listed below are our most popular laminates, which are available at standard pricing and lead times.

Formica
Solid Color Portfolio (Matte Finish)
Patterns
Formations Collection
Woodgrains

If you would like to see an expanded offering, please visit Formica's web site at formica.com.

You may also call Formica at 1-800-FORMICA for samples.

Should you require additional options, see selections at nevamar.com and wilsonartcontract.com. When you have made your selections, contact sales or customer service for pricing and lead time assistance. If the pricing or lead times are not to your satisfaction, we will be happy to help you reselect.

If your project requires something more unique, we can provide laminate from any manufacturer, including custom laminates. Please contact sales or customer service for assistance with pricing, lead times, and minimum order requirements.

EDGES AND COLORS Finishes

WOOD EDGE PROFILE



2300

- Maple species wood edge
- 1/4" X 1 1/4"
- Flat profile allows tables to be ganged
- Available in any standard wood finish
- Optional custom finishes also available
- Additional wood species also available

WOOD FINISHES

Standard Woodtone	Code
Natural	WBF110
Golden	WBF112
Medium Oak	WBF122
Chestnut	WBF124
Medium Brown Mahogany	WBF126
Dark Walnut	WBF128
Light Cherry	WBF131
Amber Cherry	WBF134
Royal Mahogany	WBF136
Black	WBF154

- Standard Finish (lacquer) is WBF wood finish with semi-gloss lacquer. No upcharge.
- Wood finishes will vary due to inconsistencies in lumber and moisture; therefore we assume no responsibility for matches to exact tones. When matching the laminate patterns containing large variations in color, stain will be matched with harmonizing tone.
- Custom finishes and color matches are available with an upcharge. Sample of finish will be required for matching prior to production. Should matching require brushing, glazing, or hand wiping additional charges may apply. Factory may require a sample before quoting. See WBF Wood Finishes swatchcard for sample of finishes.

METAL FINISHES: POWDERCOAT

Powdercoat Colors	Polished Casting
Fog	CP012S
Matte Black	CP001MS
Storm	CP023S

- All tables are priced in any Grade 3 powdercoat
- See finish card or visit falconproducts.com for additional standard and nonstandard color choices

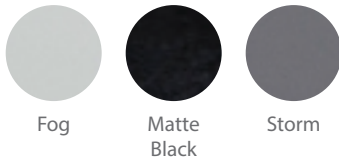

Fog

Matte Black

Storm



Shown with 1350 Series edge in Black, laminate top in Almond, and legs in Matte Black finish.

FALCON™

SPECTRA™ TABLES

WORKBOOK/PRICE LIST January 2017

DELIVERED TO ZONE 1, ADD + 4% DELIVERED TO ZONE 2

ALL PRODUCTS NOTED WITH A RED 'X' HAVE BEEN DISCONTINUED FROM OUR STANDARD LINE AND ARE AVAILABLE ON A SPECIAL ORDER BASIS. MINIMUM ORDER QUANTITIES WILL APPLY.



SQUARE TABLES

SP3F ROUND LEG
SP4F SQUARE LEG

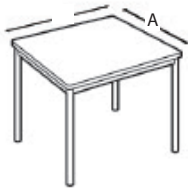

Table Size A x B	Apprx WT	1446	2326	Veneer Upcharge	Polished Chrome Upcharge
30 x 30	51	1,007	1,399	257	118
36 x 36	66	1,061	1,617	368	118
42 x 42	81	1,162	1,921	502	118
48 x 48	96	1,221	2,192	655	118

RECTANGULAR TABLES

SP3F ROUND LEG
SP4F SQUARE LEG

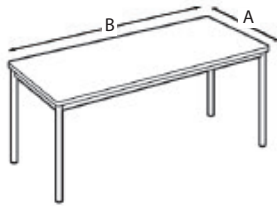
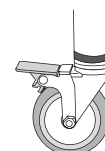

Table Size A x B	Apprx WT	1446	2326	Veneer Upcharge	Polished Chrome Upcharge
18 x 60	61	1,057	1,434	308	118
18 x 72	68	1,120	1,519	368	118
18 x 84	75	1,224	1,931	430	118
18 x 96	82	1,292	2,000	491	118
24 x 48	66	1,057	1,402	328	118
24 x 60	76	1,102	1,529	408	118
24 x 72	86	1,166	1,686	491	118
24 x 84	96	1,221	1,924	573	118
24 x 96	106	1,335	2,000	655	118
30 x 36	71	1,090	1,386	308	118
30 x 48	82	1,094	1,443	408	118
30 x 60	93	1,166	1,604	511	118
30 x 72	104	1,228	1,694	614	118
30 x 84	115	1,418	2,019	716	118
30 x 96	126	1,460	2,124	819	118
36 x 48	84	1,120	1,529	491	118
36 x 60	96	1,198	1,731	614	118
36 x 72	108	1,255	1,829	736	118
36 x 84	124	1,346	2,104	860	118
36 x 96	133	1,408	2,318	983	118

NOTES

- Standard Grade 1 Laminate and any Grade 3 Powdercoat.
- Wood edges standard in Maple. Other species available, call for pricing.
- All prices are list delivered to Zone 1. Add 4% for Zone 2.
- Standard table height: 29"



For added mobility specify the Spectra castor and add \$157 list per table. The set of four casters does not change the height of the table and must be factory installed.

STATIONARY

TRAPEZOID TABLES

SP3F ROUND LEG

SP4F SQUARE LEG

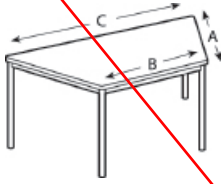

Table Size A x B x C	Apprx WT	1446	2326	Veneer Upcharge	Polished Chrome Upcharge
24 x 24 x 48	54	1,261	1,680	328	118
30 x 30 x 60	86	1,418	1,904	511	118
36 x 36 x 72	118	1,499	2,219	736	118

TRUNCATED TRIANGLE TABLES

SP3F ROUND LEG

SP4F SQUARE LEG

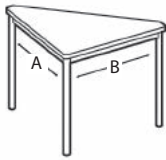

Table Size A x B	Apprx WT	1446	2326	Veneer Upcharge	Polished Chrome Upcharge
24 x 24	34	829	1,349	164	118
30 x 30	44	884	1,394	257	118
36 x 36	54	962	1,426	368	118

QUARTER ROUND TABLES

SP3F ROUND LEG

SP4F SQUARE LEG

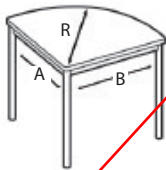

Table Size R x A/B	Apprx WT	1446	2326	Veneer Upcharge	Polished Chrome Upcharge
24 x 24	36	838	1,394	164	118
30 x 30	46	920	1,575	257	118
36 x 36	56	1,061	2,209	368	118

STATIONARY

HALF ROUND TABLES

SP3F ROUND LEG

SP4F SQUARE LEG

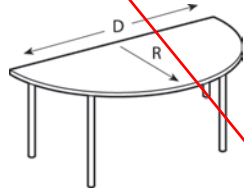

Table Size R x D	Apprx WT	1446	2326	Veneer Upcharge	Polished Chrome Upcharge
24 x 48	59	1,261	2,005	328	118
30 x 60	91	1,386	2,522	511	118
36 x 72	123	1,529	2,984	736	118

ROUND TABLES

SP3F ROUND LEG

SP4F SQUARE LEG

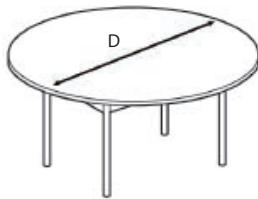

Table Size D	Apprx WT	1446	2326	Veneer Upcharge	Polished Chrome Upcharge
36	70	1,426	1,981	368	118
42	85	1,519	2,277	573	118
48	103	1,593	2,564	655	118

FOLDING

SQUARE TABLES

SP5F ROUND LEG

SP6F SQUARE LEG

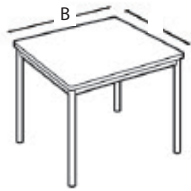

Table Size A x B	Apprx WT	1446	2326	Polished Chrome Upcharge
36 x 36	70	1,391	1,932	115
42 x 42	85	1,482	2,221	115
48 x 48	103	1,555	2,502	115

RECTANGLE TABLES

SP5F ROUND LEG

SP6F SQUARE LEG

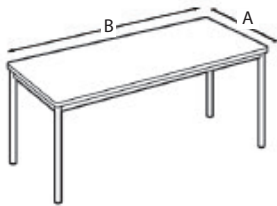
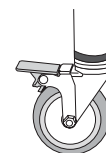

Table Size A x B	Apprx WT	1446	2326	Polished Chrome Upcharge
18 x 60	65	1,317	1,690	118
18 x 72	72	1,379	1,778	118
18 x 84	79	1,491	2,198	118
18 x 96	86	1,564	2,270	118
24 x 48	70	1,330	1,707	118
24 x 60	80	1,369	1,792	118
24 x 72	90	1,434	1,901	118
24 x 84	100	1,526	2,213	118
24 x 96	110	1,665	2,306	118
30 x 36	75	1,317	1,650	118
30 x 48	86	1,379	1,737	118
30 x 60	97	1,418	1,865	118
30 x 72	108	1,491	1,981	118
30 x 84	119	1,727	2,322	118
30 x 96	130	1,770	2,386	118
36 x 48	88	1,439	1,846	118
36 x 60	100	1,511	2,049	118
36 x 72	112	1,567	2,146	118
36 x 84	125	1,650	2,408	118
36 x 96	137	1,731	2,642	118

NOTES

- Spectra Folding Tables not available in Veneer.
- Standard Grade 1 Laminate and any Grade 3 Powdercoat.
- Wood edges standard in Maple. Other species available, call for pricing.
- All prices are list delivered to Zone 1. Add 4% for Zone 2.
- Standard table height: 29"



For added mobility specify the Spectra caster and add \$157 list per table. The set of four casters does not change the height of the table and must be factory installed.

FOLDING

TRAPEZOID TABLES

SP5F ROUND LEG
SP6F SQUARE LEG

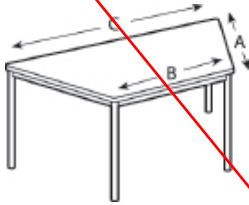

Table Size A x B x C	Apprx WT	1446	2326	Polished Chrome Upcharge
24 x 24 x 48	58	1,599	2,019	118
30 x 30 x 60	90	1,766	2,249	118
36 x 36 x 72	122	1,865	2,582	118

HALF ROUND TABLES

SP5F ROUND LEG
SP6F SQUARE LEG

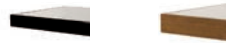
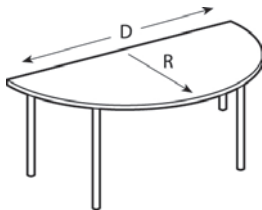

Table Size R x D	Apprx WT	1446	2326	Polished Chrome Upcharge
24 x 48	63	1,611	2,395	118
30 x 60	95	1,755	2,893	118
36 x 72	127	1,921	3,374	118

ROUND TABLES

SP5F ROUND LEG
SP6F SQUARE LEG

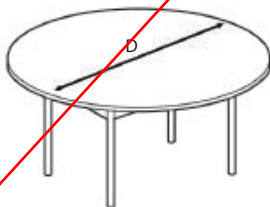

Table Size D	Apprx WT	1446	2326	Polished Chrome Upcharge
48	80	1,588	2,219	118
54	105	1,611	2,754	118
60	130	1,633	2,783	118

TRAINING STATIONARY

SQUARE TABLES
SP3FA ROUND LEG
SP4FA SQUARE LEG

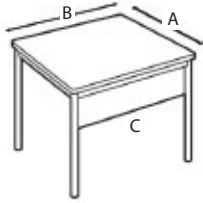

Table Size A x B	Apprx WT	1446	2326	Veneer Upcharge	Polished Chrome Upcharge
30 x 30	51	1,261	1,650	358	118
36 x 36	66	1,322	1,874	491	118
42 x 42	81	1,426	2,184	645	118
48 x 48	96	1,511	2,485	819	118

Modesty on C side

RECTANGLE TABLES
SP3FA ROUND LEG
SP4FA SQUARE LEG

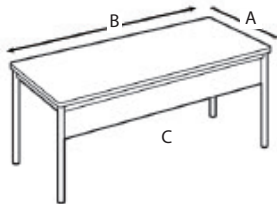
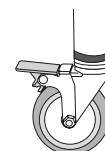

Table Size A x B	Apprx WT	1446	2326	Veneer Upcharge	Polished Chrome Upcharge
18 x 60	61	1,369	1,741	511	118
18 x 72	68	1,460	1,857	614	118
18 x 84	75	1,744	2,455	716	118
18 x 96	82	1,813	2,519	819	118
24 x 48	66	1,317	1,694	491	118
24 x 60	76	1,418	1,846	614	118
24 x 72	86	1,506	1,971	736	118
24 x 84	96	1,741	2,432	860	118
24 x 96	106	1,879	2,522	983	118
30 x 36	71	1,317	1,650	430	118
30 x 48	82	1,369	1,727	573	118
30 x 60	93	1,477	1,921	757	118
30 x 72	104	1,548	2,037	860	118
30 x 84	115	1,924	2,522	1,003	118
30 x 96	126	1,981	2,642	1,146	118
36 x 48	84	1,415	1,820	655	118
36 x 60	96	1,511	2,049	819	118
36 x 72	108	1,593	2,169	983	118
36 x 84	124	1,853	2,610	1,146	118
36 x 96	133	1,921	2,831	1,310	118

Modesty on C side

NOTES

- Standard Grade 1 Laminate and any Grade 3 Powdercoat.
- Wood edges standard in Maple. Other species available, call for pricing.
- All prices are list delivered to Zone 1. Add 4% for Zone 2.
- Standard table height: 29"



For added mobility specify the Spectra caster and add \$157 list per table. The set of four casters does not change the height of the table and must be factory installed.

TRAINING STATIONARY

TRAPEZOID TABLES

SP3FA ROUND LEG
SP4FA SQUARE LEG

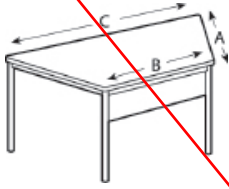

Table Size A x B x C	Apprx WT	1446	2326	Veneer Upcharge	Polished Chrome Upcharge
24 x 24 x 48	54	1,585	2,000	408	118
30 x 30 x 60	86	1,760	2,244	614	118
36 x 36 x 72	118	1,829	2,547	860	118

Modesty on B side

TRAPEZOID TABLES

SP3FA ROUND LEG
SP4FA SQUARE LEG

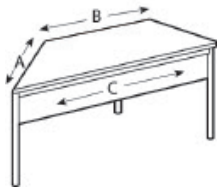

Table Size A x B x C	Apprx WT	1446	2326	Veneer Upcharge	Polished Chrome Upcharge
24 x 24 x 48	54	1,831	2,252	491	118
30 x 30 x 60	86	2,009	2,495	716	118
36 x 36 x 72	118	2,082	2,798	983	118

Modesty on C side

TRUNCATED TRIANGLE TABLES

SP3FA ROUND LEG
SP4FA SQUARE LEG

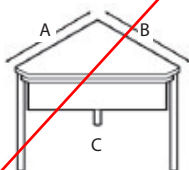

Table Size A x B	Apprx WT	1446	2326	Veneer Upcharge	Polished Chrome Upcharge
24 x 24	34	1,053	1,910	245	118
30 x 30	44	1,125	2,455	358	118
36 x 36	54	1,208	2,916	491	118

Modesty on C side

TRAINING STATIONARY

QUARTER ROUND TABLES

SP3FA ROUND LEG

SP4FA SQUARE LEG

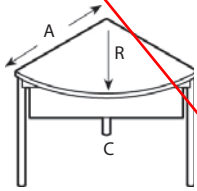

Wood Edges Only

Table Size R x A	Apprx WT	1446	2326	Veneer Upcharge	Polished Chrome Upcharge
24 x 24	36	1,102	1,656	245	118
30 x 30	46	1,203	1,857	358	118
36 x 36	56	1,346	2,492	491	118

Modesty on C side

SP3FA HALF ROUND TABLES

SP3FA ROUND LEG

SP4FA SQUARE LEG

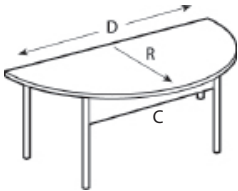

Wood Edges Only

Table Size R x D	Apprx WT	1446	2326	Veneer Upcharge	Polished Chrome Upcharge
24 x 48	59	1,585	2,330	491	118
30 x 60	91	1,731	2,870	716	118

Modesty on C side

TRAINING FOLDING

SQUARE TABLE SP5FA ROUND LEG SP6FA SQUARE LEG

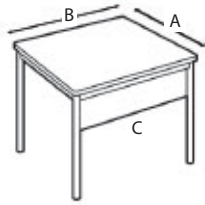

Table Size A x B	Apprx WT	1446	2326	Polished Chrome Upcharge
36 x 36	66	1,707	2,259	118
42 x 42	81	1,807	2,564	118
48 x 48	96	1,901	2,870	118

Modesty on C side

RECTANGLE TABLE SP5FA ROUND LEG SP6FA SQUARE LEG

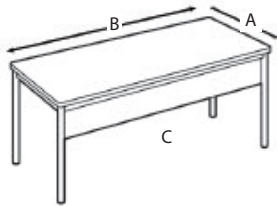

Table Size A x B	Apprx WT	1446	2326	Polished Chrome Upcharge
18 x 60	61	1,633	2,005	118
18 x 72	68	1,721	2,119	118
18 x 84	75	2,000	2,711	118
18 x 96	82	2,075	2,779	118
24 x 48	66	1,690	2,119	118
24 x 60	76	1,741	2,244	118
24 x 72	86	1,829	2,339	118
24 x 84	96	2,010	2,706	118
24 x 96	106	2,139	2,783	118
30 x 36	71	1,585	1,915	118
30 x 48	82	1,673	2,032	118
30 x 60	93	1,778	2,184	118
30 x 72	104	1,965	2,318	118
30 x 84	115	2,229	2,831	118
30 x 96	126	2,244	2,904	118
36 x 48	84	1,737	2,146	118
36 x 60	96	1,833	2,369	118
36 x 72	108	1,915	2,492	118
36 x 84	124	2,161	2,922	118
36 x 96	133	2,255	3,161	118

Modesty on C side

NOTES

- Spectra Folding Tables not available in Veneer.
- Standard Grade 1 Laminate and any Grade 3 Powdercoat.
- Wood edges standard in Maple. Other species available, call for pricing.
- All prices are list delivered to Zone 1. Add 4% for Zone 2.
- Standard table height: 29"



For added mobility specify the Spectra caster and add \$157 list per table. The set of four casters does not change the height of the table and must be factory installed.

TRAINING FOLDING

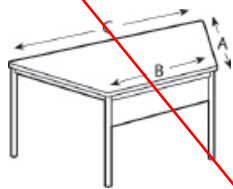

TRAPEZOID TABLE
SP5FA ROUND LEG
SP6FA SQUARE LEG



Table Size A x B x C	Apprx WT	1446	2326	Polished Chrome Upcharge
24 x 24 x 48	54	1,940	2,395	118
30 x 30 x 60	86	2,128	2,610	118
36 x 36 x 72	118	2,236	2,958	118

Modesty on B side

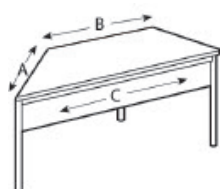

TRAPEZOID TABLE
SP5FA ROUND LEG
SP6FA SQUARE LEG



Table Size A x B x C	Apprx WT	1446	2326	Polished Chrome Upcharge
24 x 24 x 48	54	2,191	2,608	118
30 x 30 x 60	86	2,378	2,862	118
36 x 36 x 72	118	2,490	3,207	118

Modesty on C side

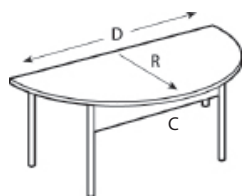

HALF ROUND TABLE
SP5FA ROUND LEG
SP6FA SQUARE LEG



Table Size R x D	Apprx WT	1446	2326	Polished Chrome Upcharge
24 x 48	59	1,931	2,678	118
30 x 60	91	2,091	3,231	118
36 x 72	123	2,259	3,716	118

Modesty on C side



- TKCEG
- \$1,737
 - Recommended for tables up to 96" long
 - Carpet over plywood

SPECIFICATIONS

HOW TO ORDER

When ordering please specify:

1. Model Number & Edge Selection Number
2. Quantity
3. Shape
4. Size
5. Base Finish
6. Top Selection (lamininate pattern number and description, veneer finish number and description)
7. Edge Finish Selection (specify wood finish and species if ordering wood edges)
8. Options
9. Small Order Charge: Orders with a combined Net price under \$1,000 will be subject to a Special Handling Charge of \$125 Net. One charge per order.

EDGE PROFILES



1446
7/8" laminate top banded with flat PVC molding.
No radius at corners.



2326
7/8" laminate top banded with 1/4" hardwood.
No radius at corners.



2326 Veneer
7/8" Veneer top banded with 1/4" hardwood.
No radius at corners.
Not recommended on Folding Tables.



MODESTY PANEL TRAINING TABLES

- Construction, edge shape and color selection same as for top.
- 8" high
- Panel folds up and locks out of view, allowing for seating on modesty panel side of table.
- On folding rectangular tables, modesty panel can remain attached when table is folded.
- On folding trapezoid tables, the modesty panel slides out of hinge brackets for removal before table is folded.

GROMMETS

- Provides wire access through table top.
- Black plastic with snap-on covers.
- Two grommets installed per table.

Power and data options available.
Call for pricing.



- 970801 - Round
- \$115 a pair
 - Size: 2-5/16" Diameter (inside dimensions).
 - Standard side location: 3-9/16" from back edge and 6-1/8" from each end.
 - Standard center location: 2-7/8" from back edge and center of table length.
 - Single location must be specified, left, right, or center, using above dimensions for placement.



- 970812 - Oval
- \$121 a pair
 - Size: 2-5/8" x 3-1/8" (inside dimensions).
 - Standard location: 3-5/16" from back edge and 6-1/8" from each end.
 - Standard center location: 3-5/16" from back edge and center of table length.
 - Single location must be specified, left, right, or center, using above dimensions for placement.

TOP CONSTRUCTION

Substrate

3/4" - 45 lb. density FSC particle board manufactured to ANSI/A208.1-1989 standards.

Lamininate

.050 thick high pressure plastic manufactured to N.E.M.A. standards, .045 thick phenolic resin sheet on underside.

Veneer

1/32" thick genuine hardwood top and bottom sealed and finished with catalyzed varnish. See color chart for finish selection. Not recommended on Folding Tables.

UNDERSTRUCTURE CONSTRUCTION



Round



Square

Legs and Stretchers

- Made from 1-1/2" diameter 16 gauge steel tubing with steel reinforcing plugs. Available in Square or Round Tubing.
- Black adjustable glides.
- Stretchers 2" high x 1" deep 17 gauge rectangular steel tubing.
- Legs and stretchers finished in same color selection.
- Finished with Powdercoat or Chrome. See color chart for finish selection.
- Clearance from floor to bottom of stretcher is 26".



SPECTRA CASTER

- The set of four casters does not change the height of the table and must be factory installed.

SPECTRA GLIDES

- Four glides per table.
- Black nylon with threaded stem.
- 1 1/2" diameter.
- Glide provides 1" adjustment of table.

SHIPPING

- Tables are shipped knocked down except for folding tables
- Accessories are packaged separately



Stationary Base

- Top is supported by 2" x 1" rectangular steel stretchers welded together into a one piece frame and fastened with #14 x 3/4" screws.
- Legs fasten to the corners of the frame with 5/16-18 x 1-1/4" bolts (2 per leg).



Folding Base

- Top is supported by 2" x 1" rectangular steel stretchers and fastened with #14 x 3/4" screws.
- Legs are joined together in pairs with similar 2" x 1" stretchers.
- The folding mechanism is a camlock design permitting operation of one pair of legs at a time.
- A lever locks the legs in both the folded and unfolded positions.
- When folded, the legs stack on top of the stretchers.
- Folded thickness: 5-7/8" (4-3/8" for rectangular tables 60" and longer).



DELUXE TRUCKS

- Eliminates the need for two person handling.
- Saves wear and tear on designer tables.

SPECIFICATIONS

- Quiet, smooth movement on 6" diameter vulcanized rubber tired roller bearing casters.
- Load capacity 2,000 lbs.– up to six tables
- Finish is black enamel with carpeted bed and horizontal rails
- Packed Weight: 115 lbs.
- 30"W x 42"L x 34"D
- Allowable total depth of tables: 26"

THIS PAGE DELIBERATELY BLANK

FALCON™

STORM™ TABLES

WORKBOOK/PRICE LIST January 2017

DELIVERED TO ZONE 1, ADD + 4% DELIVERED TO ZONE 2

ALL PRODUCTS NOTED WITH A RED 'X' HAVE BEEN DISCONTINUED FROM OUR STANDARD LINE AND ARE AVAILABLE ON A SPECIAL ORDER BASIS. MINIMUM ORDER QUANTITIES WILL APPLY.



STORM™ Easy to Move. Built to Last.



CONTENTS

Tables

Stationary	56
Flip top	61
Folding	66
Bridges	71
Adjustable Height	72

Specifications & Trucks	74
------------------------------------	----

Options	76
----------------	----

Finishes	78
-----------------	----



Optional integrated wheels shown on cantilever leg



45° struts provide strength to folding mechanism

STATIONARY

1340 edge dropped

ST3TC OR ST3CC
CLAMP ON
MODESTY PANEL

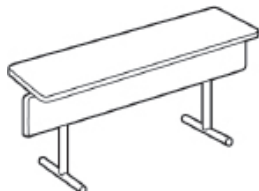

Table Size A x B	Apprx WT	Base Style	1300/ 1333/ 1340/ 1440	1444/ 2323	2405/ 2420	2344	4720	4150	Polished Chrome Upcharge	Welded Base Upcharge	Veener Upcharge
18 x 48	87	14C	999	1,074	1,378	1,218	1,133	1,526	116	51	408
18 x 60	94	14C	1,049	1,199	1,526	1,340	1,243	1,622	116	51	511
18 x 72	101	14C	1,123	1,277	1,649	1,420	1,365	1,780	116	51	614
18 x 90	110	14C	1,488	1,707	2,338	1,852	1,834	N/A	116	51	768
24 x 48	98	18T or C	1,009	1,164	1,484	1,306	1,148	1,537	116	51	491
24 x 60	108	18T or C	1,099	1,290	1,656	1,430	1,293	1,635	116	51	614
24 x 72	118	18T or C	1,210	1,398	1,810	1,541	1,448	1,792	116	51	736
24 x 90	135	18T or C	1,586	1,828	2,421	1,964	1,936	N/A	116	51	921
30 x 48	118	24T	1,060	1,203	1,532	1,346	1,228	1,731	116	51	573
30 x 60	131	24T	1,183	1,368	1,760	1,511	1,404	1,865	116	51	716
30 x 72	142	24T	1,274	1,473	1,910	1,615	1,534	2,086	116	51	860
30 x 90	176	24T	1,760	1,884	2,500	2,030	2,148	N/A	116	51	1,075

- ST3TC- Symmetrical end base
- ST3CC- Cantilever end base
- First two numbers of base style is base dimension
- Veneer available only on: 2323, 2344, 2405, 2420

1340 edge dropped

ST3TA OR ST3CA
FOLDING
MODESTY PANEL

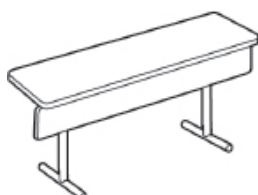

Table Size A x B	Apprx WT	Base Style	1300/ 1333/ 1340/ 1440	1444/ 2323	2405/ 2420	2344	4720	4150	Polished Chrome Upcharge	Welded Base Upcharge	Veener Upcharge
24 x 48	98	18T or C	1,169	1,327	1,643	1,466	1,307	1,695	116	51	491
24 x 60	108	18T or C	1,257	1,449	1,816	1,592	1,453	1,635	116	51	614
24 x 72	118	18T or C	1,505	1,693	2,103	1,834	1,743	1,953	116	51	736
24 x 90	135	18T or C	1,880	2,124	2,716	2,265	2,255	N/A	116	51	921
30 x 48	118	18T	1,223	1,364	1,689	1,506	1,390	1,893	116	51	573
30 x 60	131	24T	1,345	1,532	1,919	1,671	1,565	2,025	116	51	716
30 x 72	142	24T	1,569	1,767	2,207	1,910	1,830	2,247	116	51	860
30 x 90	176	24T	2,054	2,182	2,794	2,322	2,471	N/A	116	51	1,075

- ST3TA- Symmetrical end base
- ST3CA- Cantilever end base
- First two numbers of base style is base dimension
- Veneer available only on: 2323, 2344, 2405, 2420



STORM WHEEL OPTION
For added mobility specify the Storm Wheel and add \$167 per table. The Storm Wheel replaces one pair of end caps in an end base table up to 96" in length and facilitates easy movement for reconfiguring tables – merely pick up one end of the table and move.

STATIONARY

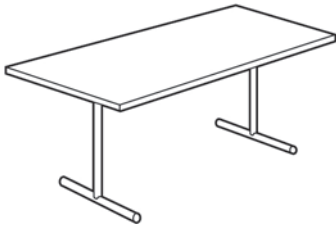

1340 edge dropped



ST3T OR ST3C RECTANGULAR

Table Size A x B	Apprx WT	Base Style	1300/ 1333/ 1340/ 1440	1444/ 2323	2405/ 2420	2344	4720	4150	Polished Chrome Upcharge	Welded Base Upcharge	Veener Upcharge
18 x 48	51	14T or C	708	787	1,092	927	844	1,203	116	51	245
18 x 60	58	14T or C	729	877	1,203	1,018	924	1,300	116	51	308
18 x 72	65	14T or C	770	927	1,294	1,069	1,011	1,460	116	51	368
18 x 90	76	14T or C	1,105	1,324	1,953	1,464	1,452	N/A	116	51	460
24 x 48	64	18T or C	720	876	1,193	1,018	858	1,217	116	51	328
24 x 60	73	18T or C	778	968	1,337	1,111	973	1,313	116	51	408
24 x 72	82	18T or C	855	1,046	1,456	1,186	1,097	1,474	116	51	491
24 x 90	97	18T or C	1,202	1,444	2,038	1,585	1,549	N/A	116	51	614
30 x 48	74	24T	772	916	1,240	1,057	940	1,411	116	51	408
30 x 60	86	24T	866	1,049	1,439	1,189	1,083	1,545	116	51	511
30 x 72	98	24T	922	1,119	1,557	1,262	1,181	1,765	116	51	614
30 x 90	115	24T	1,373	1,499	2,119	1,643	1,765	N/A	116	51	768
36 x 48	83	24T	837	1,008	1,340	1,150	1,027	1,497	116	51	491
36 x 60	98	24T	907	1,108	1,588	1,245	1,170	1,765	116	51	614
36 x 72	112	24T	979	1,156	1,707	1,297	1,291	1,957	116	51	736
36 x 90	133	24T	1,447	1,692	2,236	1,833	1,936	N/A	116	51	921
42 x 84	163	32TT	1,687	1,764	2,463	1,906	2,338	N/A	173	51	1,003
42 x 96	180	32TT	1,697	1,809	2,626	1,948	2,349	N/A	173	51	1,146
48 x 96	199	38TT	1,744	1,868	2,671	2,006	N/A	N/A	173	51	1,310
48 x 120	262	38TT (3) Legs	2,184	2,355	3,247	2,496	N/A	N/A	229	51	1,638
48 x 144*	299	38TT (3) Legs	2,348	2,562	3,537	2,702	N/A	N/A	229	51	1,964
60 x 120	309	38TT (3) Legs	2,364	2,562	3,481	2,702	N/A	N/A	229	51	2,046
60 x 144*	356	38TT (3) Legs	2,555	2,799	3,797	2,942	N/A	N/A	229	51	2,455

* Tables 144" or longer ship in two pieces

- **ST3T**- Symmetrical end base
- **ST3C**- Cantilever end base
- First two numbers of base style is base dimension
- "TT" in base number represents two column -end base
- Veneer available only on: 2323, 2344, 2405, 2420

NOTES

- Standard Grade 1 Laminate and any Grade 3 Powdercoat.
- Wood edges standard in Maple. Other species available, call for pricing.
- All prices are list delivered to Zone 1. Add 4% for Zone 2.
- Standard table height: 28 3/4"
- Shipped knocked down



STORM WHEEL OPTION

For added mobility specify the Storm Wheel and add \$167 per table. The Storm Wheel replaces one pair of end caps in an end base table up to 96" in length and facilitates easy movement for reconfiguring tables – merely pick up one end of the table and move.

STATIONARY

- Grade 3 powdercoat, Grade 1 laminate, standard wood finish
- Several optional power solutions available
 - Grommets optional, see power solutions

1340 edge dropped

**ST3X
ROUND PEDESTAL BASE**



Wood Edges Only



26S
32S-3



38Q

Table Size	Apprx WT	Bases	Base Size	1300 / 1333 1340 / 1440	1444 / 2323	2405 / 2420	2344	4150	Polished Chrome Upcharge	Welded Base Upcharge	Veneer Upcharge
30 Round	42	1	26S	711	866	1,417	1,007	N/A	116	51	257
36 Round	52	1	26S	759	945	1,515	1,082	N/A	116	51	368
42 Round	65	1	32S-3	954	1,186	1,757	1,331	N/A	116	51	502
48 Round	79	1	32S-3	974	1,228	1,817	1,372	2,238	116	51	655
54 Round	125	1	38Q	1,405	1,736	2,676	1,878	N/A	173	N/A	829
60 Round	142	1	38Q	1,419	1,778	2,708	1,921	3,156	173	N/A	1,024

- ST3X- Pedestal Base

1340 edge dropped

**ST3X
SQUARE PEDESTAL BASE**



Wood Edges Only

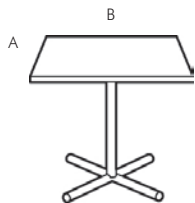

26S
32S-3

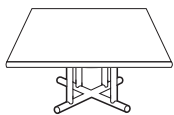

38Q

Table Size A x B	Apprx WT	Bases	Base Size	1300 / 1333 1340 / 1440	1444 / 2323	2405 / 2420	2344	Polished Chrome Upcharge	Welded Base Upcharge	Veneer Upcharge
30 x 30	48	1	26S	683	801	1,071	945	116	51	257
36 x 36	62	1	32S-3	780	904	1,210	1,046	116	51	368
42 x 42	78	1	32S-3	911	1,090	1,458	1,228	116	51	502
48 x 48	125	1	38Q	1,144	1,336	1,760	1,476	173	N/A	655
54 x 54	145	1	38Q	1,381	1,736	2,127	1,878	173	N/A	829
60 x 60	168	1	38Q	1,447	1,778	2,295	1,921	173	N/A	1,024

- ST3X- Pedestal Base
- T one column end base
- TT two column end base

1340 edge dropped

**ST3X
RECTANGULAR
PEDESTAL BASE**



Wood Edges Only

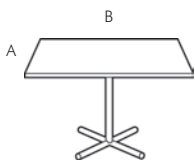

26S
32S-3

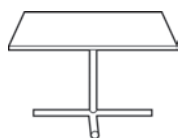

38M-3

Table Size A x B x C	Apprx WT	Bases	Base Size	1300 / 1333 1340 / 1440	1444 / 2323	2405 / 2420	2344	Polished Chrome Upcharge	Welded Base Upcharge	Veneer Upcharge
24 x 30	43	1	26S	651	765	1,012	905	116	51	206
24 x 36	47	1	26S	683	796	1,071	936	116	51	245
30 x 36	55	1	32S-3	734	864	1,154	1,006	116	51	308
30 x 48	68	1	38M-3	824	963	1,290	1,106	173	51	408
36 x 48	77	1	38M-3	887	1,056	1,388	1,199	173	51	491

- ST3X- Pedestal Base
- T one column end base
- TT two column end base

NOTES

- Standard Grade 1 Laminate and any Grade 3 Powdercoat.
- Wood edges standard in Maple. Other species available, call for pricing.
- All prices are list delivered to Zone 1. Add 4% for Zone 2.
- Standard table height: 28 3/4"
- Storm wheel not available with X Base

Veneer is Maple Long Grain, Oak available at same price, Order Must Specify

STATIONARY

- Grade 3 powdercoat, Grade 1 laminate, standard wood finish
- Several optional power solutions available
 - Grommets optional, see power solutions

1340 edge dropped



ST3T RACETRACK

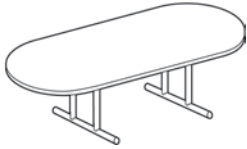

Wood Edges Only

Table Size A x B	Apprx WT	Bases	Base Size	1300 / 1333 1340 / 1440	1444 / 2323	2405 / 2420	2344	Polished Chrome Upcharge	Welded Base Upcharge	Veneer Upcharge
36 x 72	112	2	24T	1,078	1,291	1,954	1,434	116	51	736
42 x 84	163	2	32TT	1,870	1,962	2,804	2,104	173	51	1,003
42 x 96	180	2	32TT	1,885	2,012	2,999	2,157	173	51	1,146
48 x 96	199	2	38TT	1,940	2,082	3,049	2,223	173	51	1,310
48 x 120	262	3	38TT	2,406	2,609	3,680	2,755	229	51	1,638
48 x 144	299	3	38TT	2,602	2,859	4,028	2,998	229	51	1,964
60 x 120	309	3	38TT	2,618	2,859	3,957	2,998	229	51	2,046
60 x 144	356	3	38TT	2,845	3,144	4,341	3,289	229	51	2,455

- * Tables 144" or longer ship in two pieces
- ST3T- Symmetrical end base

1340 edge dropped



ST3T BOATSHAPE

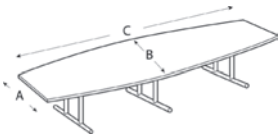

Wood Edges Only

Table Size A x B x C	Apprx WT	Bases	Base Size	1300 / 1333 1340 / 1440	1444 / 2323	2405 / 2420	2344	Polished Chrome Upcharge	Welded Base Upcharge	Veneer Upcharge
30 x 42 x 96	181	2	32TT	1,885	2,012	2,999	2,157	173	51	1,146
36 x 48 x 120	262	3	38TT	2,406	2,365	3,680	2,504	229	51	1,638
36 x 48 x 144	299	3	38TT	2,602	2,569	4,028	2,711	229	51	1,964
42 x 60 x 192	450	3	38TT	4,944	4,654	7,368	4,794	229	51	3,274

- * Tables 144" or longer ship in two pieces
- ST3T- Symmetrical end base

NOTES

- Standard Grade 1 Laminate and any Grade 3 Powdercoat.
- Wood edges standard in Maple. Other species available, call for pricing.
- All prices are list delivered to Zone 1. Add 4% for Zone 2.
- Standard table height: 28 3/4"

Veneer is Maple Long Grain, Oak available at same price, Order Must Specify

STATIONARY

ST3T
TRAPEZOID

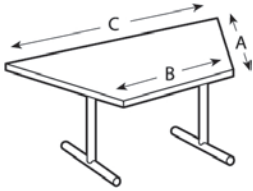

Table Size A x B x C	Apprx WT	Base Style	1333/ 1440	2323	2420	Polished Chrome Upcharge	Welded Base Upcharge	Veener Upcharge
24 x 24 x 48	74	14T	938	1,133	1,458	116	51	328
30 x 30 x 60	90	18T	1,127	1,359	1,862	116	51	511
36 x 36 x 72	106	24T	1,277	1,510	2,233	116	51	736

- **ST3T**- Symmetrical end base
- First two numbers of base style is base dimension
- Veneer available only on: 2323, 2420

ST3T
QUARTER ROUND

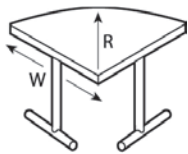

Table Size W x R	Apprx WT	Base Style	1333/ 1440	2323	2420	Polished Chrome Upcharge	Welded Base Upcharge	Veener Upcharge
30 x 30	67	18T	936	1,112	1,365	116	51	257
36 x 36	77	24T	974	1,156	1,519	116	51	368

- **ST3T**- Symmetrical end base
- First two numbers of base style is base dimension
- Veneer available only on: 2323, 2420

ST3T
HALF ROUND

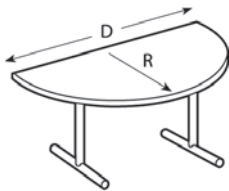

Table Size R x D	Apprx WT	Base Style	1333/ 1440	2323	2420	Polished Chrome Upcharge	Welded Base Upcharge	Veener Upcharge
24 x 48	90	14T	917	1,112	1,435	116	51	328
30 x 60	108	18T	1,105	1,338	1,837	116	51	511
36 x 72	126	24T	1,257	1,489	2,213	116	51	736

- **ST3T**- Symmetrical end base
- First two numbers of base style is base dimension
- Veneer available only on: 2323, 2420

ST3T
CRESCENT

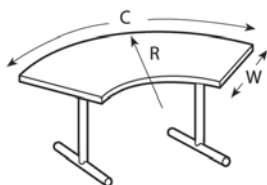
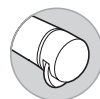

Table Size W x R x C	Apprx WT	Base Style	1333/ 1440	2323	2420	Polished Chrome Upcharge	Welded Base Upcharge	Veener Upcharge
24 x 48 x 75.5	69	18T	1,245	1,479	1,959	116	51	1,024
30 x 60 x 94	123	24T	1,853	2,004	2,811	116	51	778
36 x 72 x 113	152	24T	1,945	2,133	3,339	116	51	2,313

- **ST3T**- Symmetrical end base
- First two numbers of base style is base dimension
- Veneer available only on: 2323, 2420

NOTES

- Standard Grade 1 Laminate and any Grade 3 Powdercoat.
- Wood edges standard in Maple. Other species available, call for pricing.
- All prices are list delivered to Zone 1. Add 4% for Zone 2.
- Standard table height: 28 3/4"
- Shipped knocked down



STORM WHEEL OPTION

For added mobility specify the Storm Wheel and add \$167 per table. The Storm Wheel replaces one pair of end caps in an end base table up to 96" in length and facilitates easy movement for reconfiguring tables – merely pick up one end of the table and move.

FLIP TOP/NESTING - SINGLE HANDLE OPERATION

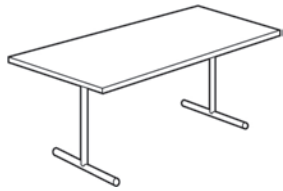

- **ST6TN** - Symmetrical end base - Flip Top/Nesting
- **ST6CN** - Cantilever End Base - Flip Top/Nesting
- Single center handle mechanism
- Stabilizing bar between legs
- First two numbers of base style is base dimension

1340 edge dropped



ST6TN OR ST6CN RECTANGLE

Table Size A x B	Apprx WT	Base Style	1300/ 1333/ 1340/ 1440	1444/ 2323	2405/ 2420	2344	4720	4150	Polished Chrome Upcharge
24 x 42	85	18T or C	839	976	1,256	1,100	959	1,275	116
24 x 48	90	18T or C	960	1,117	1,435	1,258	1,096	1,458	116
24 x 60	97	18T or C	1,017	1,210	1,576	1,348	1,215	1,552	116
24 x 72	107	18T or C	1,098	1,288	1,694	1,428	1,337	1,713	116
30 x 42	104	24T	885	1,010	1,296	1,134	1,034	1,446	116
30 x 48	109	24T	1,012	1,155	1,482	1,297	1,181	1,653	116
30 x 60	122	24T	1,106	1,290	1,677	1,433	1,327	1,782	116
30 x 72	138	24T	1,164	1,360	1,800	1,499	1,421	2,004	116
36 x 48	122	24T	1,077	1,245	1,581	1,388	1,269	1,740	116
36 x 60	138	24T	1,150	1,346	1,828	1,488	1,411	2,004	116
36 x 72	154	24T	1,221	1,396	1,948	1,539	1,532	2,199	116

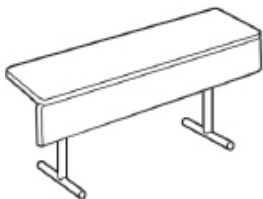

- **ST6TNM** - Symmetrical End Base - Flip Top/Nesting
- **ST6CNM** - Cantilever End Base - Flip Top/Nesting
- Single center handle mechanism
- Stabilizing bar between legs

1340 edge dropped



ST6TNM OR ST6CNM MODESTY PANEL

Table Size A x B	Apprx WT	Base Style	1300/ 1333/ 1340/ 1440	1444/ 2323	2405/ 2420	2344	4720	4150	Polished Chrome Upcharge
24 x 42	97	18T or C	1,128	1,265	1,543	1,389	1,247	1,563	116
24 x 48	102	18T or C	1,249	1,405	1,724	1,547	1,388	1,778	116
24 x 60	110	18T or C	1,337	1,531	1,897	1,670	1,534	1,875	116
24 x 72	129	18T or C	1,448	1,639	2,049	1,779	1,689	2,036	116
30 x 42	110	24T	1,173	1,299	1,584	1,423	1,321	1,733	116
30 x 48	115	24T	1,301	1,444	1,768	1,586	1,471	1,971	116
30 x 60	134	24T	1,425	1,609	1,998	1,755	1,644	2,104	116
30 x 72	148	24T	1,515	1,713	2,150	1,854	1,970	2,323	116

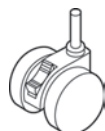

451056 - DUAL WHEEL LOCKING CASTERS \$135 (SET OF 4)

- 2-1/2" Diameter
- If ordered with table will not increase table height.
- If retrofitted will increase table height 2".
- Color: Black plastic.
- Available on: ST6TN, ST6CN, ST6TNM, ST6CNM, ST6X and ST6TB Stationary, Butterfly Flip and Folding Tables.



STORM WHEEL OPTION

For added mobility specify the Storm Wheel and add \$167 per table. The Storm Wheel replaces one pair of end caps in an end base table up to 96" in length and facilitates easy movement for reconfiguring tables – merely pick up one end of the table and move.

FLIP TOP

1340 edge dropped



ST6X
SQUARE

Table Size A x B	Apprx WT	Base Style	1300/ 1333/ 1340/ 1440	1444/ 2323	2405/ 2420	2344	Polished Chrome Upcharge
30 x 30	63	26S	801	921	1,188	1,061	116
36 x 36	85	32S-3	899	1,025	1,331	1,166	116

- ST6X- Pedestal Base / Flip Top
- First two numbers of base style is base dimension

1340 edge dropped



ST6X
RECTANGLE

Table Size A x B	Apprx WT	Base Style	1300/ 1333/ 1340/ 1440	1444/ 2323	2405/ 2420	2344	Polished Chrome Upcharge
24 x 30	60	26S	770	887	1,133	1,027	116
24 x 36	72	26S	801	916	1,188	1,056	116
30 x 36	79	32S-3	855	983	1,273	1,123	116

- ST6X- Pedestal Base / Flip Top
- First two numbers of base style is base dimension

1340 edge dropped



ST6X
ROUND

Diameter	Apprx WT	Base Style	1300/ 1333/ 1340/ 1440	1444/ 2323	2405/ 2420	2344	4150	Polished Chrome Upcharge
30	63	26S	831	984	1,537	1,125	N/A	116
36	78	32S-3	878	1,061	1,637	1,204	N/A	116
42	98	32S-3	1,075	1,310	1,874	1,449	N/A	116
48	135	32S-3	1,098	1,348	1,940	1,492	2,359	116

- ST6X- Pedestal Base / Flip Top
- First two numbers of base style is base dimension

NOTES

- Standard Grade 1 Laminate and any Grade 3 Powdercoat.
- Wood edges standard in Maple. Other species available, call for pricing.
- All prices are list delivered to Zone 1. Add 4% for Zone 2.
- Standard table height: 28 3/4"
- Shipped knocked down
- Storm wheel not available with X Base

FLIP TOP/NESTING - DOUBLE HANDLE OPERATION

1340 edge dropped

ST6T
RECTANGLE

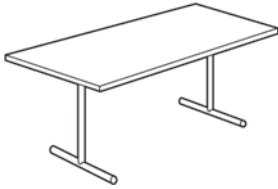

Table Size A x B	Apprx WT	Base Style	1300/ 1333/ 1340/ 1440	1444/ 2323	2405/ 2420	2344	4720	4150	Polished Chrome Upcharge
24 x 48	90	18T	960	1,117	1,435	1,258	1,096	1,458	116
24 x 60	97	18T	1,017	1,210	1,576	1,348	1,215	1,552	116
24 x 72	107	18T	1,098	1,288	1,694	1,428	1,337	1,713	116
30 x 48	109	24T	1,012	1,155	1,482	1,297	1,181	1,653	116
30 x 60	122	24T	1,106	1,290	1,677	1,433	1,327	1,782	116
30 x 72	138	24T	1,164	1,360	1,800	1,499	1,421	2,004	116
36 x 48	122	24T	1,077	1,245	1,581	1,388	1,269	1,740	116
36 x 60	138	24T	1,150	1,346	1,828	1,488	1,411	2,004	116
36 x 72	154	24T	1,221	1,396	1,948	1,539	1,532	2,199	116

- ST6T- Symmetrical end base / Flip Top
- First two numbers of base style is base dimension

1340 edge dropped

ST6TC
CLAMP ON
MODESTY PANEL

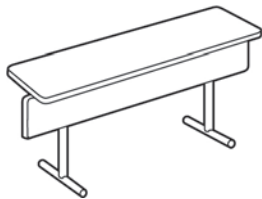
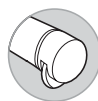

Table Size A x B	Apprx WT	Base Style	1300/ 1333/ 1340/ 1440	1444/ 2323	2405/ 2420	2344	4720	4150	Polished Chrome Upcharge
24 x 48	102	18T	1,249	1,405	1,724	1,547	1,388	1,778	116
24 x 60	110	18T	1,337	1,531	1,897	1,670	1,534	1,875	116
24 x 72	129	18T	1,448	1,639	2,049	1,779	1,689	2,036	116
30 x 48	115	24T	1,301	1,444	1,768	1,586	1,471	1,971	116
30 x 60	134	24T	1,425	1,609	1,998	1,755	1,644	2,104	116
30 x 72	148	24T	1,515	1,713	2,150	1,854	1,970	2,323	116

- ST6TC- Symmetrical end base / Flip Top
- First two numbers of base style is base dimension



STORM WHEEL OPTION

For added mobility specify the Storm Wheel and add \$167 per table. The Storm Wheel replaces one pair of end caps in an end base table up to 96" in length and facilitates easy movement for reconfiguring tables – merely pick up one end of the table and move.

FLIP TOP/NESTING - DOUBLE HANDLE OPERATION

**ST6T
TRAPEZOID**

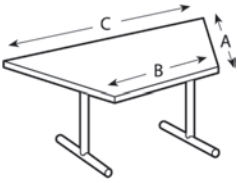

Table Size A x B x C	Apprx WT	Base Style	1333/ 1440	2323	2420	Polished Chrome Upcharge
24 x 24 x 48	78	14T	1,178	1,343	1,695	116
30 x 30 x 60	94	18T	1,367	1,572	2,102	116
36 x 35 x 72	110	24T	1,519	1,726	2,474	116

- **ST6T**- Symmetrical end base / Flip Top
- First two numbers of base style is base dimension

**ST6T
HALF ROUND**

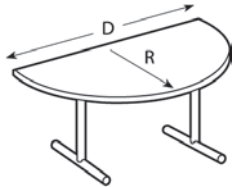

Table Size R x D	Apprx WT	Base Style	1333/ 1440	2323	2420	Polished Chrome Upcharge
24 x 48	94	14T	1,156	1,343	1,673	116
30 x 60	112	18T	1,346	1,572	2,084	116
36 x 72	130	24T	1,496	1,726	2,454	116

- **ST6T**- Symmetrical end base / Flip Top
- First two numbers of base style is base dimension

**ST6T
CRESCENT**

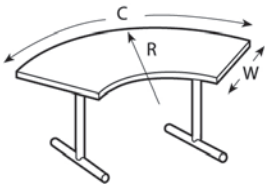

Table Size W x R x C	Apprx WT	Base Style	1333/ 1440	2323	2420	Polished Chrome Upcharge
24 x 48	73	18T	1,489	1,596	2,202	116
30 x 60	127	24T	2,094	2,115	3,050	116
36 x 72	156	24T	2,183	2,244	3,580	116

- **ST6T**- Symmetrical end base / Flip Top
- First two numbers of base style is base dimension

NOTES

- Standard Grade 1 Laminate and any Grade 3 Powdercoat.
- Wood edges standard in Maple. Other species available, call for pricing.
- All prices are list delivered to Zone 1. Add 4% for Zone 2.
- Standard table height: 28 3/4"
- Shipped knocked down

BUTTERFLY FLIP TOP

1340 edge dropped

ST6TB RECTANGLE

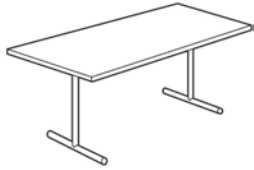

Table Size A x B	Apprx WT	Base Style	1300/ 1333/ 1340/ 1440	1444/ 2323	2405/ 2420	2344	4720	Polished Chrome Upcharge
30 x 48	109	24T	1,300	1,459	1,783	1,600	1,421	116
30 x 60	122	24T	1,394	1,569	1,985	1,735	1,565	116
30 x 72	138	24T	1,466	1,594	2,102	1,810	1,661	116

- **ST6TB**- Symmetrical end base / Butterfly Flip Top
- First two numbers of base style is base dimension

1340 edge dropped

ST6TB TRAPEZOID

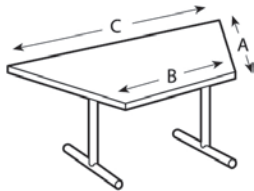
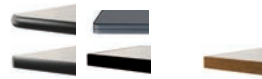

Table Size A x B x C	Apprx WT	Base Style	1300/ 1333/ 1340/ 1440	2323	Polished Chrome Upcharge
30 x 30 x 60	94	18T	1,670	1,902	116

- **ST6TB**- Symmetrical end base / Butterfly Flip Top
- First two numbers of base style is base dimension

1340 edge dropped

ST6TB HALF ROUND

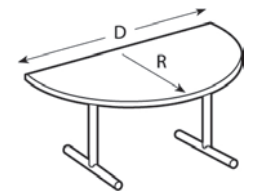

Table Size A x B x C	Apprx WT	Base Style	1300/ 1333/ 1340/ 1440	2323	Polished Chrome Upcharge
30 x 60	112	18T	1,649	1,880	116

- **ST6TB**- Symmetrical end base / Butterfly Flip Top
- First two numbers of base style is base dimension

NOTES

- Standard Grade 1 Laminate and any Grade 3 Powdercoat.
- Wood edges standard in Maple. Other species available, call for pricing.
- All prices are list delivered to Zone 1. Add 4% for Zone 2.
- Standard table height: 28 3/4"
- Shipped assembled.
- Top is removable



STORM WHEEL OPTION

For added mobility specify the Storm Wheel and add \$167 per table. The Storm Wheel replaces one pair of end caps in an end base table up to 96" in length and facilitates easy movement for reconfiguring tables – merely pick up one end of the table and move.

FOLDING

1340 edge dropped

ST5T SQUARE

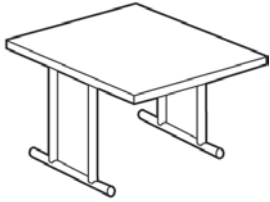

Table Size A x B	Apprx WT	Base Style	1300/ 1333/ 1340/ 1440	1444/ 2323	2405/ 2420	2344	Polished Chrome Upcharge
60 x 60*	249	38TT	1,766	1,778	2,295	2,243	173

- *Overfold base
- **ST5T**- Symmetrical end base
- First two numbers of base style is base dimension
- "TT" in base number represents two column end base

1340 edge dropped

ST5T RECTANGLE

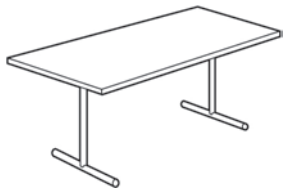

Table Size A x B	Apprx WT	Base Style	1300/ 1333/ 1340/ 1440	1444/ 2323	2405/ 2420	2344	4150	Polished Chrome Upcharge
18 x 48*	74	14T	1,028	1,108	1,411	1,245	1,600	116
18 x 60	81	14T	1,049	1,199	1,526	1,340	1,671	116
18 x 72	88	14T	1,094	1,245	1,616	1,388	1,836	116
18 x 90	103	14T	1,424	1,643	2,273	1,783	N/A	116
24 x 48*	86	18T	1,042	1,198	1,515	1,340	1,671	116
24 x 60	96	18T	1,099	1,290	1,656	1,430	1,702	116
24 x 72	105	18T	1,173	1,366	1,775	1,509	1,874	116
24 x 90	127	18T	1,523	1,764	2,358	1,904	N/A	116
30 x 48*	106	24T	1,096	1,233	1,562	1,377	1,874	116
30 x 60	110	24T	1,183	1,369	1,760	1,511	1,949	116
30 x 72	122	24T	1,241	1,440	1,878	1,584	2,184	116
30 x 90	170	24T	1,693	1,824	2,439	1,960	N/A	116
36 x 48*	115	24T	1,157	1,330	1,658	1,470	2,019	116
36 x 60	122	24T	1,227	1,426	1,907	1,566	2,184	116
36 x 72	136	24T	1,299	1,477	2,029	1,617	2,399	116
36 x 90	188	24T	1,766	2,011	2,559	2,156	N/A	116

- * Overfold base
- **ST5T**- Symmetrical end base
- First two numbers of base style is base dimension

NOTES

- Standard Grade 1 Laminate and any Grade 3 Powdercoat,
- Folding Tables not available with Veneer.
- Wood edges standard in Maple. Other species available, call for pricing.
- All prices are list delivered to Zone 1. Add 4% for Zone 2.
- Standard table height: 28 3/4"



STORM WHEEL OPTION

For added mobility specify the Storm Wheel and add \$161 per table. The Storm Wheel replaces one pair of end caps in an end base table up to 96" in length and facilitates easy movement for reconfiguring tables – merely pick up one end of the table and move.

LIGHT WEIGHT FOLDING

1347 edge dropped

ST5T LIGHT WEIGHT RECTANGLE

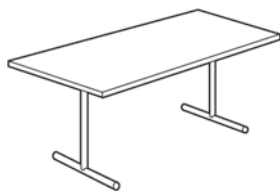

Table Size A x B	Apprx WT	Base Style	1307/ 1337/ 1347/ 1447	1448/ 2327	2407/ 2427	2348	4157	Polished Chrome Upcharge
18 x 60	65	14T	1,101	1,245	1,572	1,390	1,671	116
18 x 72	70	14T	1,153	1,310	1,673	1,449	1,836	116
18 x 90	81	14T	1,496	1,721	2,348	1,863	N/A	116
24 x 60	76	18T	1,165	1,353	1,724	1,495	1,702	116
24 x 72	82	18T	1,256	1,447	1,861	1,589	1,874	116
24 x 90	99	18T	1,622	1,865	2,456	2,004	N/A	116
30 x 60	86	24T	1,271	1,452	1,844	1,596	1,949	116
30 x 72	94	24T	1,343	1,541	1,983	1,684	2,184	116
30 x 90	134	24T	1,820	1,948	2,564	2,089	N/A	116
36 x 60	94	24T	1,331	1,528	2,006	1,669	2,184	116
36 x 72	103	24T	1,419	1,597	2,146	1,738	2,399	116
36 x 90	145	24T	1,917	2,168	2,709	2,304	N/A	116

- **ST5T**- Symmetrical end base
- First two numbers of base style is base dimension



STORM WHEEL OPTION

For added mobility specify the Storm Wheel and add \$167 per table. The Storm Wheel replaces one pair of end caps in an end base table up to 96" in length and facilitates easy movement for reconfiguring tables – merely pick up one end of the table and move.

LIGHT WEIGHT FOLDING

1347 edge dropped

ST5TA LIGHT WEIGHT FOLDING MODESTY PANEL

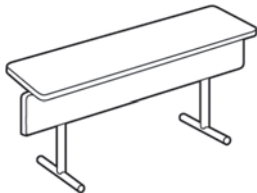

Table Size A x B	Apprx WT	Base Style	1307/ 1337/ 1347/ 1447	1448/ 2327	2407/ 2427	2348	4157	Polished Chrome Upcharge
24 x 60	83	18T	1,485	1,673	2,044	1,817	2,182	116
24 x 72	91	18T	1,608	1,800	2,210	1,942	2,354	116
24 x 90	102	18T	2,005	2,248	2,838	2,390	N/A	116
30 x 60	97	24T	1,592	1,772	2,162	1,916	2,429	116
30 x 72	110	24T	1,693	1,890	2,334	2,036	2,666	116
30 x 90	103	24T	2,204	2,334	2,945	2,474	N/A	116

- **ST5TA**- Symmetrical end base
- First two numbers of base style is base dimension
- Butterfly Flip Top Tables w/ removable top

1347 edge dropped

ST5CR LIGHT WEIGHT REMOVABLE MODESTY PANEL

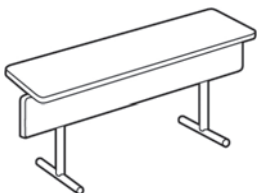
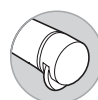

Table Size A x B	Apprx WT	Base Style	1307/ 1337/ 1347/ 1447	1448/ 2327	2407/ 2427	2348	4157	Polished Chrome Upcharge
18 x 48*	74	14C	1,421	1,566	1,893	1,712	1,910	116
18 x 60	81	14C	1,505	1,660	2,029	1,803	2,021	116
18 x 72	95	14C	1,881	2,102	2,731	2,247	2,194	116

- *Overfold base
- **ST5CR**- Cantilever end base
- First two numbers of base style is base dimension

NOTES

- Standard Grade 1 Laminate and any Grade 3 Powdercoat,
- Folding Tables not available with Veneer.
- Wood edges standard in Maple. Other species available, call for pricing.
- All prices are list delivered to Zone 1. Add 4% for Zone 2.
- Standard table height: 28 3/4"
- Shipped assembled.



STORM WHEEL OPTION

For added mobility specify the Storm Wheel and add \$167 per table. The Storm Wheel replaces one pair of end caps in an end base table up to 96" in length and facilitates easy movement for reconfiguring tables – merely pick up one end of the table and move.

FOLDING

1340 edge dropped

ST5CR REMOVABLE MODESTY PANEL



Table Size A x B	Apprx WT	Base Style	1300/ 1333/ 1340/ 1440	1444/ 2323	2405/ 2420	2344	4150	Polished Chrome Upcharge
18 x 48*	82	14C	1,315	1,395	1,697	1,537	1,922	112
18 x 60	91	14C	1,369	1,519	1,845	1,658	1,993	112
18 x 72	100	14C	1,445	1,599	1,965	1,740	2,161	112
18 x 90	118	14C	1,810	2,029	2,656	2,173	N/A	112

- *Overfold base
 • **ST5CR**- Cantilever end base
 • First two numbers of base style is base dimension

1340 edge dropped

ST5TA FOLDING MODESTY PANEL



Table Size A x B	Apprx WT	Base Style	1300/ 1333/ 1340/ 1440	1444/ 2323	2405/ 2420	2344	4150	Polished Chrome Upcharge
24 x 48*	106	18T	1,331	1,485	1,806	1,627	2,154	116
24 x 60	115	18T	1,418	1,609	1,980	1,754	2,182	116
24 x 72	130	18T	1,529	1,721	2,130	1,863	2,223	116
24 x 90	150	18T	1,860	2,094	2,674	2,232	N/A	116
30 x 48*	126	24T	1,380	1,526	1,851	1,666	2,354	116
30 x 60	70	24T	1,506	1,689	2,078	1,831	2,429	116
30 x 72	153	24T	1,596	1,791	2,231	1,938	2,666	116
30 x 90	175	24T	2,078	2,207	2,823	2,348	N/A	116

- *Overfold base
 • **ST5TA**- Symmetrical end base
 • First two numbers of base style is base dimension

1340 edge dropped

ST5T ROUND

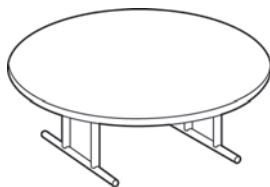

Table Size D	Apprx WT	Base Style	1300/ 1333/ 1340/ 1440	1444/ 2323	2405/ 2420	2344	4150	Polished Chrome Upcharge
60*	194	32TT	1,941	2,300	3,226	2,441	3,677	173

- *Overfold base
 • **ST5T**- Symmetrical end base
 • First two numbers of base style is base dimension
 • "TT" in base number represents two column end base



STORM WHEEL OPTION

For added mobility specify the Storm Wheel and add \$167 per table. The Storm Wheel replaces one pair of end caps in an end base table up to 96" in length and facilitates easy movement for reconfiguring tables – merely pick up one end of the table and move.

FOLDING

1340 edge dropped

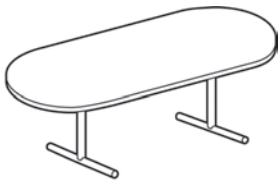

**ST5T
RACETRACK**



Table Size A x B	Apprx WT	Base Style	1300/ 1333/ 1340/ 1440	1444/ 2323	2405/ 2420	2344	Polished Chrome Upcharge
36 x 72	166	24T	1,599	1,812	2,474	1,954	116

- **ST5T**- Symmetrical end base
- First two numbers of base style is base dimension

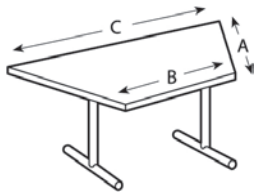

**ST5T
TRAPEZOID**



Table Size A x B x C	Apprx WT	Base Style	1333/ 1440	2323	2420	Polished Chrome Upcharge
36 x 36 x 72*	117	24T	1,599	1,866	2,556	116

- *Overfold base
- **ST5T**- Symmetrical end base
- First two numbers of base style is base dimension

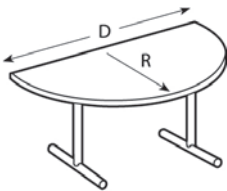

**ST5T
HALF ROUND**



Table Size R x D	Apprx WT	Base Style	1333/ 1440	2323	2420	Polished Chrome Upcharge
24 x 48*	97	14T	1,237	1,526	1,757	116
30 x 60*	116	18T	1,425	1,714	2,162	116
36 x 72*	134	24T	1,581	1,857	2,534	116

- *Overfold base
- **ST5T**- Symmetrical end base
- First two numbers of base style is base dimension

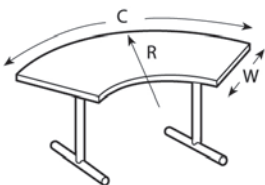

**ST5T
CRESCENT**



Table Size W x R x C	Apprx WT	Base Style	1333/ 1440	2323	2420	Polished Chrome Upcharge
30 x 60 x 94*	143	24T	2,175	2,380	3,131	116
36 x 72 x 113	165	24T	2,266	2,509	3,662	116

- *Overfold base
- **ST5T**- Symmetrical end base
- First two numbers of base style is base dimension

NOTES

- Standard Grade 1 Laminate and any Grade 3 Powdercoat,
- Folding Tables not available with Veneer.
- Wood edges standard in Maple. Other species available, call for pricing.
- All prices are list delivered to Zone 1. Add 4% for Zone 2.
- Standard table height: 28 3/4"
- Shipped assembled.

BRIDGES

STB BRIDGES

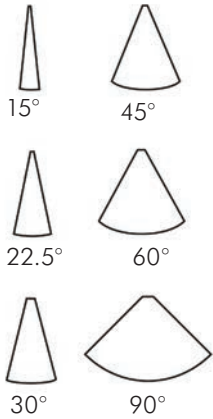

Degree Angle	Apprx WT	Width	1440	2323	Veener Upcharge
15°	5	24	398	466	286
22.5°	7	24	398	466	292
30°	10	24	454	602	292
45°	15	24	424	567	324
60°	20	24	454	608	348
90°	30	24	398	528	507
15°	8	30	478	645	255
22.5°	12	30	454	602	330
30°	15	30	454	602	354
45°	23	30	478	645	385
60°	31	30	515	700	412
90°	46	30	454	608	579
15°	11	36	496	700	337
22.5°	17	36	496	700	368
30°	22	36	496	700	400
45°	33	36	641	858	515
60°	44	36	713	989	573

STSB SQUARE BRIDGE

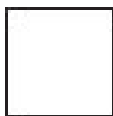

Table Size A x B	Apprx WT	1440	2323	Veener Upcharge
24 x 24	19	317	405	164
30 x 30	29	356	460	257
36 x 36	42	398	520	368

NOTES

- Standard Grade 1 Laminate and any Grade 3 Powdercoat.
- Wood edges standard in Maple. Other species available, call for pricing.
- All prices are list delivered to Zone 1. Add 4% for Zone 2.
- Standard table height: 28 3/4"
- For use with all Stationary, Flip, and Folding Tables
- Must be Ganged
- Veneer available only on 2323



STORM WHEEL OPTION

For added mobility specify the Storm Wheel and add \$167 per table. The Storm Wheel replaces one pair of end caps in an end base table up to 96" in length and facilitates easy movement for reconfiguring tables – merely pick up one end of the table and move.

ADJUSTABLE HEIGHT

ST7X
ROUND

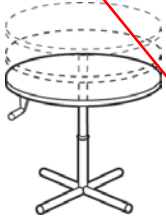

Table Size D	Apprx WT	Column Type	1333/ 1440	2323	Veener Upcharge
30	59	ROUND	QUOTE	QUOTE	QUOTE
36	77	ROUND	QUOTE	QUOTE	QUOTE
42	127	ROUND	QUOTE	QUOTE	QUOTE
48	151	ROUND	QUOTE	QUOTE	QUOTE

Tables adjust from a sitting height of 26" to a standing height of 39".

- ST7X- Pedestal Base
- Veneer available only on 2323

ST7X
SQUARE

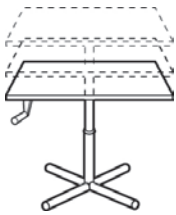

Table Size A x B	Apprx WT	Column Type	1333/ 1440	2323	Upcharge Veneer
30 x 30	60	ROUND	QUOTE	QUOTE	QUOTE
36 x 36	90	ROUND	QUOTE	QUOTE	QUOTE
42 x 42	128	ROUND	QUOTE	QUOTE	QUOTE

Tables adjust from a sitting height of 26" to a standing height of 39".

- ST7X- Pedestal Base
- Veneer available only on 2323

NOTES

- Standard Grade 1 Laminate and any Grade 3 Powdercoat.
- Wood edges standard in Maple. Other species available, call for pricing.
- Storm wheel not available on X bases
- All prices are list delivered to Zone 1. Add 4% for Zone 2.
- Standard table height: 28 3/4"
- Shipped assembled.

ADJUSTABLE HEIGHT

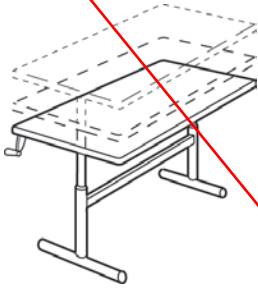

ST7T RECTANGLE



Table Size A x B	Apprx WT	Column Type	1333/ 1440	2323	4720	Veneer Upcharge
18 x 48	78	ROUND	QUOTE	QUOTE	QUOTE	QUOTE
18 x 60	87	ROUND	QUOTE	QUOTE	QUOTE	QUOTE
18 x 72	95	ROUND	QUOTE	QUOTE	QUOTE	QUOTE
18 x 90	107	ROUND	QUOTE	QUOTE	QUOTE	QUOTE
24 x 48	90	ROUND	QUOTE	QUOTE	QUOTE	QUOTE
24 x 60	101	ROUND	QUOTE	QUOTE	QUOTE	QUOTE
24 x 72	112	ROUND	QUOTE	QUOTE	QUOTE	QUOTE
24 x 90	129	ROUND	QUOTE	QUOTE	QUOTE	QUOTE
30 x 48	114	ROUND	QUOTE	QUOTE	QUOTE	QUOTE
30 x 60	113	ROUND	QUOTE	QUOTE	QUOTE	QUOTE
30 x 72	126	ROUND	QUOTE	QUOTE	QUOTE	QUOTE
30 x 90	156	ROUND	QUOTE	QUOTE	QUOTE	QUOTE
36 x 48	114	ROUND	QUOTE	QUOTE	QUOTE	QUOTE
36 x 60	128	ROUND	QUOTE	QUOTE	QUOTE	QUOTE
36 x 72	142	ROUND	QUOTE	QUOTE	QUOTE	QUOTE
36 x 90	168	ROUND	QUOTE	QUOTE	QUOTE	QUOTE

Tables adjust from a sitting height of 26" to a standing height of 39".
 If using 4720, the Post Formed edge will be on the handle side of the top.
 • **ST7T** - Symmetrical end base
 • Veneer available only on 2323

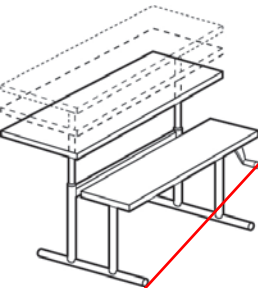

ST7TS SPLIT TOP



Table Size R x D	Apprx WT	Column Type	1333/ 1440	2323	4720	Veneer Upcharge
36 x 48	137	ROUND	QUOTE	QUOTE	QUOTE	QUOTE
36 x 60	154	ROUND	QUOTE	QUOTE	QUOTE	QUOTE
36 x 72	170	ROUND	QUOTE	QUOTE	QUOTE	QUOTE

Two separately adjustable work surfaces enable greater technology management flexibility.
 Both surfaces adjust from a minimum of 24" to a maximum of 36".
 If using 4720, the Post Formed edge will be on the handle side of the top.
 • **ST7T S** - Symmetrical end base
 • Veneer available only on 2323

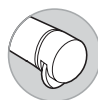

STORM WHEEL OPTION

For added mobility specify the Storm Wheel and add \$167 per table. The Storm Wheel replaces one pair of end caps in an end base table up to 96" in length and facilitates easy movement for reconfiguring tables – merely pick up one end of the table and move.

SPECIFICATIONS

HOW TO ORDER

When ordering please specify:

1. Model Number & Edge Selection Number
2. Quantity
3. Shape
4. Size
5. Base Finish
6. Top Selection (laminite pattern number and description, veneer finish number and description)
7. Edge Finish Selection (specify wood finish and species if ordering wood edges)
8. Options
9. Small Order Charge
Orders with a combined Net price under \$1,000 will be subject to a Special Handling Charge of \$125 Net. One charge per order.

EDGE AND MODESTY PROFILES



4720 Postformed
1-1/4" plastic laminate top. The front edge is sloped, reducing strain on the wrist. The side and rear edge are banded with rigid PVC molding.
Modesty edge 1440



1300 / 1307 Bumper T-Mold
1-1/4" laminate top. The edges are banded with solid vinyl "T" molding, with 7/8" radius at corners.
Modesty edge 1300



1333 / 1337 Eased T-Mold
1-1/4" laminate top. The edges are banded with solid vinyl "T" molding, with 1" radius at corners.
Modesty edge 1300



4150 / 4157 Sloped Urethane
1-1/4" laminate top. The front urethane edge is sloped, reducing strain on the wrist. The sides and rear have a flat urethane edge.
Modesty edge 1440



1340 / 1347 Reveal T-Mold
1-1/4" laminate top. The edges are banded with 5/16" solid vinyl "T" molding, with 7/8" radius at corners.
Modesty edge 1300



1440 / 1447 Flat PVC
1-1/4" laminate top. The edges are banded with flat PVC molding. No radius at corners.
Modesty edge 1440



1444 / 1448 Flat PVC
1-3/4" laminate top. The edges are banded with flat PVC molding. No radius at corners.
Modesty edge 1440



2405 / 2407 Wood Bullnose
1-1/4" laminate top. The edges are banded with hardwood. No radius at corners.
Modesty edge Flat Wood Band



2323 / 2327 Wood Band
1-1/4" laminate top. The edges are banded with 1/4" hardwood. No radius at corners.
Modesty edge Flat Wood Band



2344 / 2348 Wood Band
1-3/4" laminate top. The edges are banded with 1/4" hardwood. No radius at corners.
Modesty edge Flat Wood Band



2420 / 2427 Wood Edge
1-1/4" laminate top. The edges are banded with hardwood. No radius at corners.
Modesty edge Flat Wood Band

STANDARD TABLE HEIGHT: 28 3/4"

TOP CONSTRUCTION

Substrate

High density 45 lb. core with backing sheet

Laminite

.050 thick high pressure plastic manufactured to N.E.M.A. standards, .045 thick phenolic resin sheet on underside.

Veneer

1/32" thick genuine hardwood top which is stained and sealed on the bottom. Veneer not available with light weight core. Specify: oak, walnut, mahogany, maple, cherry. Edge species are the same as that of top veneer. See color chart for finishes. Not recommended on Folding Tables.

Light Weight Top

Most light weight tops produced using light weight composite wood construction, specially designed to provide light weight rigidity. The core is 7/8" thick. Edges are built up to 1-1/4" using 1/4" fiberboard on perimeter of frame. Tops are balanced construction with plastic laminite or veneer surfaces and phenolic backer.

UNDERSTRUCTURE SPECIFICATIONS

GLIDES

Adjustable glides are standard on all tables.

- 1-3/8" diameter black nylon with steel support housing
- 5/16-18 x 1" threaded stem



Legs

- **ST3T Stationary**
- **ST5T Folding**
- **ST6T Flip Top**
- **ST8T C-Leg**
- Inverted "T"-shape or double "T" (TT) depending on top width.
- Made from 1-3/4" diameter 14 gauge steel tubing.



Pedestal Base

- **ST3X Stationary**
- **ST5X Folding**
- **ST6X Flip Top**
- Foot - "X" shaped made with 1-3/4" diameter 14 gauge steel tubing.
- Column - one 2-1/4" diameter 14 gauge, or one 3" diameter 16 gauge, or four 1-3/4" diameter 14 gauge steel tubing depending on top size.
- Single column bases bolt together with a single 1/2"-13" x 26-1/4" long bolt. The bolt threads up through X-foot, column and into threaded insert in mounting plate.
- Four-column bases bolted together using eight 1/2"-13 bolts threaded into steel inserts welded into columns.
- Mounting plates are 10" x 10"-7 gauge cold formed steel for single column bases.
- 14" x 14"- 7 gauge for four-column bases.

END CAPS

- Die cast aluminum pressed in place.
- Black reveal rings are sandwiched between end cap and tube end.



Stationary Base

- **ST3 Series**
- 10" square 7 gauge cold formed steel mounting plates bolt to the leg columns.
- 1/2-13 x 1-1/2" long steel hex head bolts thread through the mounting plates and into steel inserts welded within the column.
- Each leg assembly fastens to the top with eight #14 x 3/4" long custom particle board screws.
- Tables greater than 72" have 2 bent steel rails screwed to the bottom of the top.

JOINTS

Continuous brazed welded for maximum strength.

FINISHES

Finished with powdercoat or optional chrome plating.



Folding Base

- **ST5T T-Base**
- **ST5C C-Leg**
- Self-supporting chassis made of two 1/8" thick L-shaped steel rails support the legs and folding mechanism.
- Rails act as stiffeners to resist top sag.
- Twin die cast zinc/aluminum diagonal braces are used as leg supports on ST5T Folding Series.
- Twin stamped steel braces are used on ST5T Folding Double end base Series.
- Latching devices will automatically engage to lock legs in their upright position.
- Folded thickness: 4-1/2".

DELUXE TRUCKS

- Saves wear and tear on tables.
- One person can set-up or knock down.
- Quiet, smooth movement on 6" diameter vulcanized rubber tired roller bearing casters.
- Load capacity 2,000 lbs.- up to six tables
- Finish is black enamel with carpeted bed.

SPECIFICATIONS

- Packed Weight: 115 lbs.
- 30"W x 42"L x 34"D
- Allowable total depth of tables: 26"



TKCEG

- \$1,737
- Recommended for folding tables up to 96" long
- Carpet over plywood

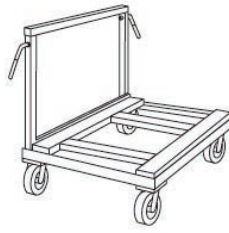

TDDEG

- \$1,737
- Recommended for round tables up to 60" diameter
- Carpet over steel

STANDARD TRUCKS

TFHGR

- \$1,513
- Recommended for folding tables up to 96" long
- Packed Weight: 175 lbs.
- 36"W x 99"L x 39-1/2"H
- Allowable total depth of tables: 18-36"
- Hardwood Platform



TFRGH

- \$1,572
- Recommended for Flip Top tables up to 48" long
- Packed Weight: 135 lbs.
- 36"W x 51"L x 39-1/2"H
- Allowable total depth of tables: 24-36"
- Plywood platform

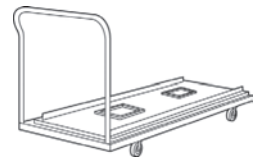

OPTIONS

FLIP TOP AND NESTING

- Allows the top to rotate into a vertical position for space saving when not in use
- Nesting width: approximately 9"

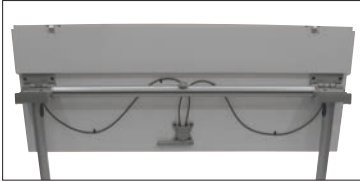

Flip Top/Nesting - Single Handle

- **ST6TN/ST6TNM Symmetrical Base**
- **ST6CN/ST6CNM Cantilever Base**
- Nests tightly reducing space requirements
- Single centered handle for easier top adjustment
- Stabilizing bar provides rigid support
- Available with Storm wheels or casters



Flip Top/Nesting - Double Handle

- **ST6X Pedestal Base**
- **ST6T T-Base**
- Top separates from base for added space savings.
- Mechanism is constructed of 7 gauge steel which hinges open in a clam shell fashion when a release handle is pulled.
- Latching devices will automatically engage when top is rotated back to its usable position.
- Casters not available.

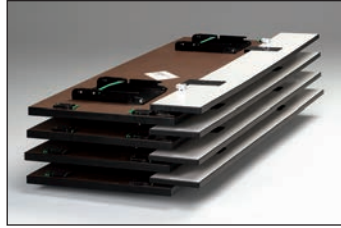

Butterfly Flip Mechanism

- **ST6TB Series**
- Top cannot be separated from base.
- Constructed with two cast aluminum arms. Spring loaded action to engage and release mechanism.
- Caster option available.

ADJUSTABLE HEIGHT

- Inner column and attached gear housing finished in black oxide
- Crank stores unobtrusively by telescoping in and up under top
- Standard crank placement is right side
- Lift rate: 9 cranks per inch of adjustment
- Maximum recommended lift capacity: 300 pounds



Adjustable Height T-Base

- **ST7T Series**
- Overall appearance similar to ST3T Stationary base table.
- 1-5/8" inner column telescopes out of 1-7/8" outer column.
- Leg assemblies are joined together with 1" x 2-1/2" 14 gauge steel trestle bar, finished in black powdercoat.
- Crank handle can be located on left or right side of table.
- Height range: 26" to 39".

Adjustable Height Split Top

- **ST7TS Series**
- Overall leg appearance similar to the ST3T Stationary "TT" base.
- 1-5/8" inner columns telescope out of 1-7/8" outer columns.
- Leg assemblies are joined together with 1" x 2-1/2" 14 gauge steel trestle bar, finished in black powdercoat.

- Has two tops; each top adjusts independently of the other.
- Rear top uses a removable crank handle mounted over top surface. Handle stores in bracket mounted under top.
- Front top has telescoping crank handle which stores by sliding up under top.
- Top widths: rear top 19", front top 16".
- Height range: 24" to 36".

Adjustable Height Pedestal Base ST7X Series

- Overall appearance similar to ST3X Stationary Series pedestal base.
- 2-5/8" inner column telescopes out of a 3" outer column.
- Height range: 26" to 39".

MODESTY PANELS

- Constructed of 3/4", 47 lb. density particle board conforming to ANCIA208.1
- Grade 1-M-S surfaced with .050" high pressure laminate, manufactured to NEMA standards.
- Edge material is 7/8" vinyl molding, PVC, or wood banding, and matches top edge color, PVC or wood banding. See Edge and Modesty Profiles



Clamp on modesty panels

- ST3T and ST6T Series
- Fastened to the leg with black finished clamps
- Individually packed and installed in the field
- Height 10"

Folding Modesty Panel

- ST5T Folding Table
- Permanently attached with hinges and catches
- Height 8"
- Shipped separately

Removable Modesty Panel

- ST5T Folding Table
- 18" wide tables have removable panels with slip hinges
- Panels must be removed before tables are folded
- Height 8"

GROMMETS

- Provides wire access through table top.
- Black plastic with snap-on covers.
- Two grommets installed per table.
- Single location must be specified left, right, or center using dimensions below for placement.



970801 - Round

- \$115 a pair
- Size: 2-5/16" Diameter (inside dimensions).
- Standard side location: 3-9/16" from back edge and 6-1/8" from each end.
- Standard center location: 2-7/8" from back edge and center of table length.



970812 - Oval

- \$121 a pair
- Size: 2-5/8" x 3-1/8" (inside dimensions).
- Standard side location: 3-5/16" from back edge and 6-1/8" from each end.
- Standard center location: 3-5/16" from back edge and center of table length.

WIRE MANAGEMENT



WL27 - Legway Wireway \$86

- Covers and routes wires up the table leg.
- Manager mounts on inside or outside of leg.
- Plastic clip holds legway against leg.
- Constructed of .047" thick, C-shaped aluminum extrusion.
- Finish: Powdercoat to match leg.
- Not available in polished chrome.
- Size: 1-3/4" wide x 7/8" deep.



WMB - Wire Mesh Bag

Available on tables with modesty panels

WMB36	36"	\$211
WMB48	48"	\$215
WMB60	60"	\$260
WMB72	72"	\$337
WMB84	84"	\$373
WMB90	90"	\$416

GANGING

- Set of locks is two male, two female, half set installed on both ends of top.

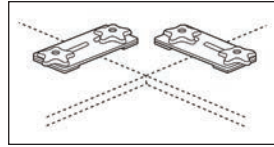

QL Quick Lock Ganging Mechanism

Factory installed

QL1 1 1/4" Top \$178

QL2 1 3/4" Top \$178

- Must be ordered with table.
- Specify ganging configuration, e.g. end to end, side to end, side to side, etc

Customer installed.

QL1 1 1/4" Top \$95

QL2 1 3/4" Top \$95

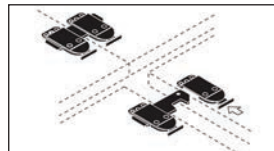

FL-4 Fast Lock Ganging Mechanism \$127

- Factory installed — must be ordered with table.
- Gangs tables and bridges end-to-end.
- Must be used on 1-1/4" tables only

UNIVERSAL WIRE MANAGER



UWMA48 48" \$647

UWMA60 60" \$708

UWMA72 72" \$757

- ST5 and ST3 Series
- The Universal Wire Manager can be added in the field.
- Wire Manager must be removed before table is folded.
- Not available on: round, racetrack, quarter round, half-round or crescent shapes.

MOBILITY

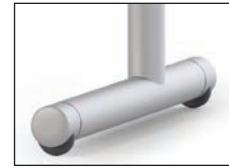

STORM WHEEL - \$167

- Must be ordered with table.
- Replaces two end caps in one end of an end base table up to 96".
- Color: Black plastic.



451056 - Dual Wheel Locking Casters \$167 (set of 4)

- 2-1/2" Diameter
- If ordered with table will not increase table height.
- If retrofitted will increase table height 2".
- Color: Black plastic.
- Available only on: ST6X, ST6TB, ST6TN/ST6TNM and ST6CN/ST6CNM Stationary, Butterfly Flip and Folding Tables.

STABILIZING GLIDES

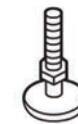

241111 \$5

- Spring loaded automatically adjusts to floor variances up to 3/8".
- Price is for one glide.

JURY BASE

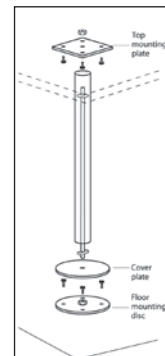

J15BD Jury Base Round Column

J15BD-12 \$566

J15BD-18 \$714

J15BD-22 \$884

J15BD-26 \$950

- Floor mounted base
- Column: 3-1/2" 16 gauge
- Floor mount: disc bolts in place
- 18 gauge spun steel cover fits over mounting disc to hide mounting hardware
- 1/2" threaded tie rod bolts to floor mounting disc
- Column ties cover rod
- Tie Rod attaches top plate to column
- Top mounting plate 10" x 10" x 7 gauge cold formed steel
- Finish: Powdercoat
- Table Height: 29"

Recommended mounting hardware (not supplied):
 Wood floors:
 1/2" x 3-1/2" long lag bolts.
 Masonry floors:
 1/2-13 x 4" hex head cap screw with female masonry anchor

MOVE TO BASES SECTION

THIS PAGE DELIBERATELY BLANK

FALCONTM

SYNTECHTM TABLES WORKBOOK/PRICE LIST January 2017

DELIVERED TO ZONE 1, ADD + 4% DELIVERED TO ZONE 2



- Cantilever Leg
- Grade 3 powdercoat standard, Grade 1 laminate standard
- Add On Tables include one set GA2 gangers
- When using Add On Tables, gangers required on Starter Tables, order must specify, add \$157 per table
- Several optional power solutions available
 - Grommets optional, see power solutions
- Greater than standard height add \$98, less than add \$49

**25OCS
STARTER**



Wood Edges
Only

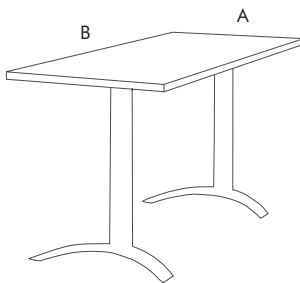

Table Size (A x B)	13500 / 13333 / 1440	23000	24000	4720 Postform	Veneer Upcharge
24 x 48	799	868	1,059	908	328
24 x 54	917	996	1,113	1,039	368
24 x 60	1,057	1,147	1,122	1,197	408
24 x 72	1,297	1,407	1,192	1,337	491
30 x 48	823	895	1,104	936	245
30 x 54	965	1,050	1,134	1,096	460
30 x 60	1,092	1,183	1,147	1,233	511
30 x 72	1,297	1,406	1,214	1,386	614

**25OCA
ADD ON**



Wood Edges
Only

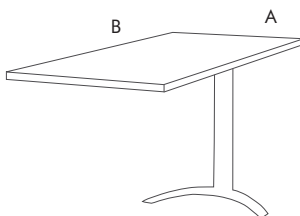

Table Size (A x B)	13500 / 13333 / 1440	23000	24000	4720 Postform	Veneer Upcharge
24 x 48	646	711	907	755	328
24 x 54	765	839	960	885	368
24 x 60	905	989	969	1,044	408
24 x 72	1,145	1,250	1,039	1,183	491
30 x 48	668	738	953	782	245
30 x 54	815	894	983	942	460
30 x 60	938	1,027	994	1,080	511
30 x 72	1,145	1,249	1,059	1,232	614

- Cantilever Leg
- Includes 8" Modesty Panel.
- Grade 3 powdercoat standard, Grade 1 laminate standard
- Add On Tables include one set GA2 gangers
- When using Add On Tables, gangers required on Starter Tables, order must specify, add \$157 per table
- Several optional power solutions available
 - Grommets optional, see power solutions
- Greater than standard height add \$98, less than add \$49

25OCSM STARTER W/MODESTY



Wood Edges Only

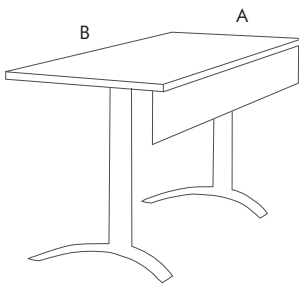

Table Size (A x B)	13500 / 13333 / 1440	23000	24000	4720 Posiform	Veneer Upcharge
24 x 48	980	980	1,065	928	491
24 x 54	1,103	1,103	1,113	1,044	553
24 x 60	1,123	1,248	1,122	1,182	614
24 x 72	1,349	1,499	1,192	1,420	736
30 x 48	905	1,005	1,104	952	408
30 x 54	1,040	1,156	1,134	1,095	645
30 x 60	1,155	1,283	1,147	1,216	716
30 x 72	1,348	1,498	1,214	1,419	860

25OCAM ADD ON W/MODESTY



Wood Edges Only

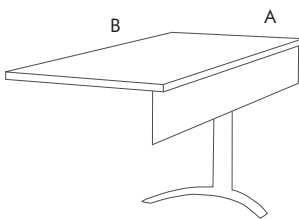
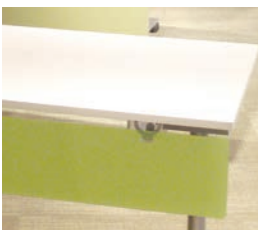

Table Size (A x B)	13500 / 13333 / 1440	23000	24000	4720 Posiform	Veneer Upcharge
24 x 48	752	851	936	799	491
24 x 54	863	974	983	915	553
24 x 60	994	1,119	993	1,053	614
24 x 72	1,219	1,369	1,063	1,291	736
30 x 48	775	876	975	823	408
30 x 54	911	1,027	1,005	966	645
30 x 60	1,026	1,154	1,017	1,087	716
30 x 72	1,218	1,254	1,085	1,290	860

KRYSTALCAST MODESTY PANEL



Panel Size (A x B)	Price
7 x 42	419
7 x 48	441
7 x 60	465
7 x 72	487

- Frosted or Solid color, same pricing.

- Symmetrical and Cantilever Legs
- 25NSM AND 25NCM Include 8" Modesty Panel
- Grade 3 powdercoat standard, Grade 1 laminate standard
- Convenient single center handle
- Stabilizing bar increases stability
 - Grommets optional, see power solutions
- Several optional power solutions available
- Casters optional



Casters
Available for Symmetrical
and Cantilever Legs
\$143/set of 4

**25NS (SYMMETRICAL)
25NC(CANTILEVER)
FLIP/NESTING**

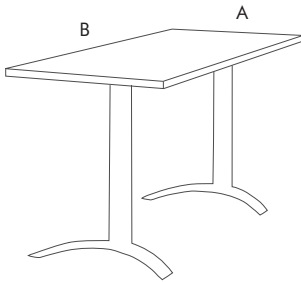

Table Size (A x B)	13500 / 13333 / 1440	23000	24000	4720 Postform
24 X 42	993	1,035	1,216	1,086
24 x 48	1,131	1,179	1,392	1,240
24 x 60	1,390	1,450	1,453	1,529
24 x 72	1,628	1,704	1,526	1,669
30 X 42	1,012	1,055	1,255	1,108
30 x 48	1,155	1,206	1,437	1,267
30 x 60	1,424	1,486	1,480	1,565
30 x 72	1,628	1,703	1,546	1,719

**25NSM (SYMMETRICAL)
25NCM (CANTILEVER)
FLIP/NESTING
WITH MODESTY
PANEL**

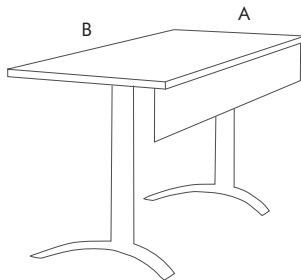

Table Size (A x B)	13500 / 13333 / 1440	23000	24000	4720 Postform
24 X 42	1,138	1,180	1,361	1,231
24 x 48	1,276	1,324	1,537	1,386
24 x 60	1,535	1,597	1,600	1,673
24 x 72	1,775	1,850	1,670	1,815
30 X 42	1,158	1,201	1,399	1,255
30 x 48	1,301	1,350	1,583	1,411
30 x 60	1,569	1,632	1,624	1,711
30 x 72	1,775	1,849	1,690	1,864

MEETING AND CONFERENCE TABLES

- Includes Symmetrical legs
- Grade 3 powdercoat standard, Grade 1 laminate standard
- Several optional power solutions available
 - Grommets optional, see power solutions
- Does not include Modesty Panel

25SS RECTANGLE



Wood Edges
Only

Table Size (A x B)	Bases	Base Size	13500 / 13333 / 1440	23000	24000 / 24022 / 24055	38350	Veneer Upcharge
30 x 60	2	22	1,013	1,082	1,257	1,395	511
30 x 72	2	22	1,218	1,247	1,508	1,675	614
30 x 84	2	22	1,419	1,452	1,759	1,953	716
30 x 96	2	22	1,621	1,660	2,008	2,231	819
30 x 120	3	22	2,029	2,076	2,512	2,789	1,024
36 x 60	2	22	1,217	1,247	1,508	1,673	614
36 x 72	2	22	1,460	1,495	1,811	2,008	736
36 x 84	2	22	1,704	1,744	2,110	2,345	860
36 x 96	2	22	1,947	1,992	2,410	2,677	983
36 x 120	3	22	2,432	2,491	3,013	3,347	1,227

MEETING AND CONFERENCE TABLES

- Includes Symmetrical legs
- Grade 3 powdercoat standard, Grade 1 laminate standard
- Does not include Modesty Panel
- Several optional power solutions available
 - Grommets optional, see power solutions
- Greater than standard height add \$98, less than add \$49



25SS RACETRACK



Wood Edges Only

Table Size (A x B)	Bases	Base Size	13500 / 13333 / 1440	23000	24000 / 24022 / 24055	38350	Veneer Upcharge
30 x 60	2	22	1,134	1,164	1,407	1,563	511
30 x 72	2	22	1,363	1,395	1,688	1,876	614
30 x 84	2	22	1,590	1,627	1,967	2,186	716
30 x 96	2	22	1,816	1,860	2,250	2,499	819
30 x 120	3	22	2,271	2,324	2,813	3,125	1,024
36 x 60	2	22	1,362	1,395	1,688	1,875	614
36 x 72	2	22	1,635	1,676	2,027	2,250	736
36 x 84	2	22	1,907	1,954	2,365	2,625	860
36 x 96	2	22	2,179	2,231	2,699	2,999	983
36 x 120	3	22	2,724	2,789	3,376	3,747	1,227



25MC MEDIA CONFERENCE



Wood Edges Only

Table Size (A x B)	Bases	Base Size	13500 / 13333 / 1440	23000	24000 / 24022 / 24055	38350	Veneer Upcharge
24 x 36 x 72	2	22	1,361	1,006	1,218	1,910	736
24 x 36 x 90	2	22	1,702	1,257	1,520	2,343	921
24 x 36 x 108	2	22	2,041	1,508	1,824	2,811	1,104
24 x 36 x 120	3	22	2,269	1,675	2,027	3,124	1,227

MULTI-SURFACE MEETING TABLES (SPECIALTY SHAPES)

- Includes Symmetrical Shared legs, three per network pod
- Grade 3 powdercoat standard, Grade 1 laminate standard
- Does not include Modesty Panel
- Several optional power solutions available
 - Grommets optional, see power solutions
- Pricing is for complete Network Pod Unit of three tables with bases

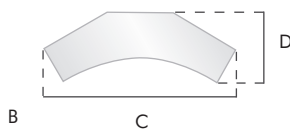
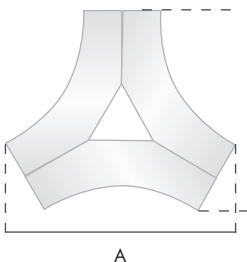

25NW NETWORK POD



Wood Edges Only

Table Size (Complete A x B) (Single C x D)	13500 / 13333	23000	Veneer Upcharge
Small (80 x 69.75) (67.25 x 24)	3,980	3,289	1,392
Large (93 x 107) (89.75 x 32.5)	5,271	4,357	2,496

MULTI-SURFACE MEETING TABLES (SPECIALTY SHAPES)

- Does not include Modesty Panel
- Grade 3 powdercoat standard, Grade 1 laminate standard
- Several optional power solutions available
 - Grommets optional, see power solutions

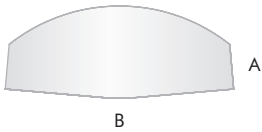

25CCE CURVED END



Wood Edges Only

Table Size (A x B)	13500 / 13333 / 1440	23000	Veneer Upcharge
30 x 72	1,235	1,494	614

- Includes two Cantilever legs and one set of Gangers
- Connects to 30" starter tables with standard modesty panel
- Starter tables may also be ordered without modesty

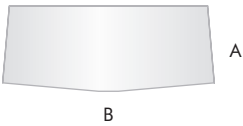

25CSE STRAIGHT END



Wood Edges Only

Table Size (A x B)	13500 / 13333 / 1440	23000	Veneer Upcharge
30 x 72	1,197	1,448	614

- Includes two Cantilever legs and one set of Gangers
- Connects to 30" starter tables with standard modesty panel
- Starter tables may also be ordered without modesty

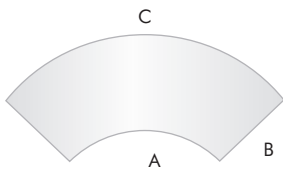

25CCR CRESCENT CONNECTOR



Wood Edges Only

Table Size (A x B x C)	13500 / 13333	23000	Veneer Upcharge
36R x 24 x 56	1,015	1,228	819
48R x 24 x 75	1,089	1,317	1,227
36R x 30 x 56	1,048	1,269	778
48R x 30 x 75	1,119	1,353	1,227

- Includes two Cantilever legs and one set of Gangers



25CHR HALF ROUND



Wood Edges Only

Table Size	13500 / 13333 / 1440	23000	Veneer Upcharge
60D	1,332	1,611	511
72D	1,665	2,012	736

- Includes two Cantilever legs and one set of Gangers.



25C45 45° CONNECTOR



Wood Edges Only

Table Size	13500 / 13333 / 1440	23000	Veneer Upcharge
24D	337	407	324
30D	346	419	385

- No Bases
- Includes one set of Gangers



25C90 90° CONNECTOR



Wood Edges Only

Table Size	13500 / 13333 / 1440	23000	Veneer Upcharge
24D	716	867	507
30D	823	996	579

- No Bases
- Includes one set of Gangers

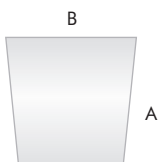

25CW WEDGE CONNECTOR



Wood Edges Only

Table Size (A x B)	13500 / 13333 / 1440	23000	Veneer Upcharge
24 x 29	313	380	201
30 x 30	407	494	257

- No Bases
- Includes one set of Gangers

STANDARD FEATURES



Modesty Panel

- Standard on 24" and 30" Training Tables
- Standard any Grade 1 laminate
- Modesty hardware matches base finish
- Optional perforated modesty
- KrystalCast Modesty



Cantilever Shared Leg



Wireway Leg

- (-P) Suffix for One Column
- (-PP) Suffix for Two Column
- One leg, specify right or left placement as seen from user side.

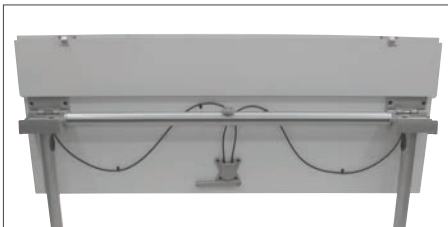

Flip/Nesting Table

- 25NS (Symmetrical) + 25NC(Cantilever)
- 25NSM (Symmetrical) + 25NCM (Cantilever)
- Symmetrical and Cantilever Legs
- Convenient single center handle
- Stabilizing bar increases stability
- Several optional power solutions available
- Casters optional

OPTIONS



Casters

Available for Symmetrical and Cantilever Legs
\$143/set of 4



Cantilever Base Only (22")
 250V-322C **\$315** GD3



Symmetrical Base Only
 250V-18S **\$315** GD3
 250V-322S **\$315** GD3



24" Mesh Wireway Bag
\$118



GRM3 & GRM2 Grommet
\$87

See "Power Solutions" section for addition power options. Grommets optional

X Base Only (22")
 250X-22 **\$424** GD1
 250X-22 **\$490** GD2
 250X-22 **\$511** GD3



GA2 Gangers

Starter tables require gangers if Add On units purchased
\$157/set

Small Order Charge: Orders with a combined Net price under \$1,000 will be subject to a Special Handling Charge of \$125 Net. One charge per order.

FLX POWER MANAGEMENT

Power is mounted in the middle of the table, allowing column to act as a vertical wire manager.



FLX Power Management is an upcharge to the table base price:

- Cord exits under base plate add **\$367** list
- Cord exits through column side add **\$367** list
- Must be specified on table base order FLX may be used on cocktail, dining, counter, and bar height versions of approved bases.

TABLE TOP EDGE PROFILES



13500 1.25" fluted vinyl edge. High pressure laminate top standard with 3" radius corners. Available in a variety of colors



13333 1.25" solid vinyl flat T mold edge. High pressure laminate top standard with 1" radius corners. Available in a variety of colors



1440 1.25 flat PVC edge band. High pressure laminate. Radius corners not available



23000 1.25" x .25" wood banded edge high pressure laminate or veneer top surface



24000 1.25" x 1.25" square wood edge high pressure laminate, veneer, or Veneer Art top surface



24022 1.25" x 1.25" half bullnose wood edge high pressure laminate, veneer, or Veneer Art top surface



24055 1.25" x 1.25" full bullnose wood edge high pressure laminate, veneer, or Veneer Art top surface



38350 1.25" x 2" beveled wood edge with high pressure laminate, veneer, or Veneer Art top surface.

FALCON™

SYMETRIS™ TABLES

WORKBOOK/PRICE LIST January 2017

DELIVERED TO ZONE 1, ADD + 4% DELIVERED TO ZONE 2



- Cantilever Leg
- Grade 3 Powdercoat Standard, Grade 1 Laminate Standard
- Several optional power solutions available
 - Grommets optional, see power solutions
- Modesty/Wire Gallery
- Vertical Wire Management
- Greater than standard height add \$98, less than add \$49

36S
STARTER

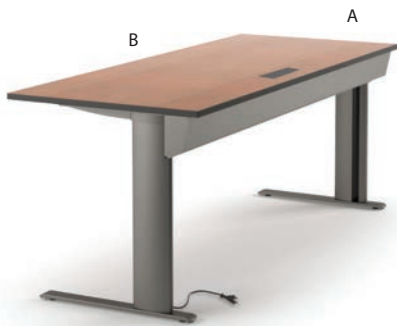

Table Size (A x B)	13500 / 13333 / 1440 / 1446	7150	7160	4720 Postform
24 x 42	1,053	1,200	1,189	1,070
24 x 48	1,085	1,214	1,206	1,085
24 x 60	1,186	1,321	1,312	1,181
24 x 72	1,264	1,402	1,393	1,258
30 x 42	1,070	1,221	1,213	1,070
30 x 48	1,106	1,235	1,226	1,101
30 x 60	1,225	1,360	1,349	1,220
30 x 72	1,313	1,452	1,442	1,302

- Optional upper screens available with 7150 or 4720 edge

36A
ADD ON

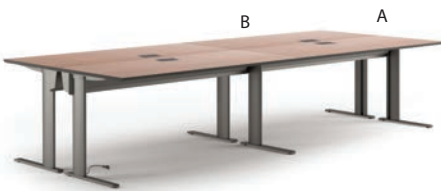

Table Size (A x B)	13500 / 13333 / 1440 / 1446	7150	7160	4720 Postform
24 x 42	806	951	943	822
24 x 48	837	964	957	837
24 x 60	940	1,073	1,063	933
24 x 72	1,015	1,155	1,146	1,010
30 x 42	822	973	963	822
30 x 48	860	988	980	854
30 x 60	979	1,113	1,102	973
30 x 72	1,066	1,206	1,195	1,055

- Symmetrical and Cantilever Legs
- 36NSM and 36NCM Include 8" Modesty Panel
- Grade 3 Powdercoat Standard, Grade 1 Laminate Standard
- Convenient single center handle
- Several optional power solutions available
 - Grommets optional, see power solutions
- Casters optional
- Optional wire way leg.



Casters
Available for Symmetrical
and Cantilever Legs
\$140/set of 4

36NSM (SYMMETRICAL)
36NCM (CANTILEVER)
FLIP/NESTING
WITH MODESTY PANEL



Table Size (A x B)	13500 / 13333 / 1440 / 1446	7150	7160	4720 Postform
24 x 42	1,549	1,721	1,684	1,580
24 x 48	1,591	1,768	1,729	1,623
24 x 60	1,676	1,862	1,822	1,709
24 x 72	1,760	1,956	1,914	1,796
30 x 42	1,634	1,815	1,776	1,667
30 x 48	1,676	1,862	1,822	1,709
30 x 60	1,760	1,956	1,914	1,796
30 x 72	1,845	2,051	2,006	1,883

KRYSTALCAST
MODESTY PANEL



Panel Size (A x B)	Price
7 x 42	419
7 x 48	441
7 x 60	465
7 x 72	487

- Frosted or Solid color, same pricing.

36NS (SYMMETRICAL)
36NC (CANTILEVER)
FLIP/NESTING



Table Size (A x B)	13500 / 13333 / 1440 / 1446	7150	7160	4720 Postform
24 x 42	1,505	1,677	1,640	1,536
24 x 48	1,548	1,725	1,686	1,580
24 x 60	1,633	1,818	1,778	1,666
24 x 72	1,706	1,902	1,860	1,742
30 x 42	1,579	1,760	1,722	1,613
30 x 48	1,621	1,808	1,767	1,655
30 x 60	1,706	1,902	1,860	1,742
30 x 72	1,780	1,986	1,941	1,818

- Cantilever Leg
- Grade 3 Powdercoat Standard, Grade 1 Laminate Standard
- Lower Modesty Panel
- Locking File Cabinet in Storm or Black Finish
- Optional Upper Screens Available



36TD
TEACHERS
DESK



Table Size (A x B)	13500 / 13333 / 1440	7150	4720 Postform
30 x 48	1,922	2,051	1,917
30 x 60	2,060	2,195	2,055
30 x 72	2,177	2,317	2,166

41LD - FREESTANDING/STARTER

Table Size	Screen Size	11" Height	17" Height
24 x 30	19 x 30	548	637
24 x 36	19 x 36		
24 x 42	19 x 42		
30 x 30	25 x 30		
30 x 36	25 x 36		
30 x 42	25 x 42	583	684
24 x 48	19 x 48		
24 x 54	19 x 54		
24 x 60	19 x 60		
30 x 48	25 x 48		
30 x 54	25 x 54	615	715
30 x 60	25 x 60		
24 x 72	19 x 72		
30 x 72	25 x 72		

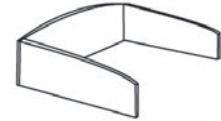

ACTIVE LEARNING TABLE

- Includes 3 Symmetrical Shared legs
- Grade 3 powdercoat standard, Grade 1 laminate standard
- 29" Standard Overall Height
- Several optional power solutions available
 - Grommets optional, see power solutions
- Pricing is for complete Active Learning Table
- Screens available with 7150 or 4720 Edge



36POD ACTIVE LEARNING TABLE



Table Size (Complete A x B) (Single C x D)	Weight	13500 / 13333
59.33 x 68.5 27" Outer Surface. 42" Inner surface	160 lbs.	1,809

400 SERIES



22 x 22
30 x 30

- Cast Iron Baseplate
- Powdercoat Finish
- 16 GA 3" Round Steel Column
- 10 x 10 Steel Spider, Black
- MPT1 Nylon Glides

OPTIONS

- \$29 Upcharge, per base set up
- \$5 Super Leveler Glides
- \$51 Per column/up to 40.75" greater than standard height (STU)
- \$52 Per column/counter height 34.75" (CH)
- \$52 Per column/wheelchair height 30" (W)
- \$20 Per column/cocktail height 16.75" (C)
- \$178 Per column standard height with wire management
- \$229 Per column/up to 40.75" greater than standard height with wire management
- \$212 Per column/wheelchair height 30" with wire management
- \$201 Per column/cocktail height 16.75" with wire management

Catalog Number	Base Spread	Spider Spread	Col. Dia.	Apprx WT	Overall Height	Grade 1	Grade 2	Grade 3
403-22	22 x 22	10	3	31	28	327	333	350
403-30	30 x 30	10	3	36	28	378	386	405

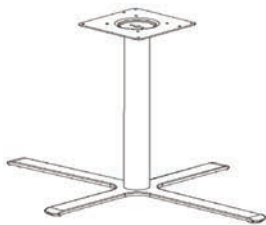

22 x 30

RECOMMENDED BASE BY TABLE TOP SIZE USING STANDARD FALCON CORE TOPS.
(Larger or heavier tops may cause instability).

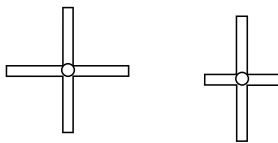

22x22
30x30

22 x 30

Top Size	400 Series
30 Round	403-22
36 Round	403-22
42 Round	403-30
30 x 30	403-22
36 x 36	403-30
42 x 42	403-30

+ = Two bases per top required

Top Size	400 Series
24 x 30	403-22
24 x 36	403-22
24 x 42	403-2230
30 x 36	403-22
30 x 42	403-2230
30 x 60	403-22 +

++ = Three bases per top required

Top Size	400 Series
30 x 72	403-22 +
30 x 84	403-22 +
30 x 96	403-22 +
30 x 108	403-22++
30 x 120	403-22 ++
30 x 144	403-22 ++
36 x 42	403-2230
36 x 48	403-22 +
36 x 54	403-22 +
36 x 60	403-30 +
36 x 72	403-30 +
36 x 84	403-30 +
36 x 96	403-30 +
36 x 108	403-30 ++
36 x 120	403-30 ++
36 x 144	403-30 ++

FLX POWER MANAGEMENT

Power is mounted in the middle of the table, allowing column to act as a vertical wire manager.

FLX Power Management is an upcharge to the table base price:

Cord exits under base plate add \$371 list

Cord exits through column side add \$371 list

Must be specified on table base order FLX may be used on cocktail, dining, counter, and bar height versions of approved bases.



FALCON™

MEETING AND CONFERENCE TABLES

WORKBOOK/PRICE LIST January 2017

DELIVERED TO ZONE 1, ADD + 4% DELIVERED TO ZONE 2





74PT EXCHANGE COMMUNITY TABLE

- Grade 1 Standard Laminate - Formica or Wilsonart only
- Additional laminate grades available, call for pricing
- Also available in Veneer-Art® and ColorCore® (see below)
- Optional power available (see below)
 - Grommets optional, see power solutions

How to order:

74PT3096SH
29" Task Height

74PT3096CH
36" Active Height

74PT3096BH
42" Active Height

Table Size	Task Height 29"	Apprx. Weight	Active Height 36"	Apprx. Weight	Active Height 42"	Apprx. Weight
30 x 72	3,364	300	3,594	348	4,041	390
30 x 84	3,757	336	4,036	389	4,554	435
30 x 96	3,793	373	4,072	431	4,591	481
36 x 72	3,563	339	3,781	392	4,253	437
36 x 84	3,974	380	4,239	437	4,783	487
36 x 96	4,010	420	4,276	482	4,821	536
42 x 72	3,932	379	4,114	436	4,634	485
42 x 84	4,403	423	4,693	485	5,225	538
42 x 96	4,440	467	4,729	534	5,273	591
48 x 72	3,951	418	4,131	480	4,651	533
48 x 84	4,422	466	4,711	532	5,244	590
48 x 96	4,457	514	4,747	590	5,279	646

LAMINART VENEER-ART

Apprx. Weight (same as above)

Table Size	Standard Height 29"	Counter Height 36"	Community Height 42"
30 x 72	21,143	21,397	21,881
30 x 84	21,584	21,874	24,973
30 x 96	24,127	24,417	25,009
36 x 72	21,349	21,590	22,110
36 x 84	21,820	22,098	25,233
36 x 96	24,363	24,642	25,269
42 x 72	21,753	21,971	25,800
42 x 84	24,792	25,106	25,722
42 x 96	24,829	25,143	25,770
48 x 72	24,278	24,496	25,063
48 x 84	24,810	25,125	28,254
48 x 96	27,360	27,673	28,289

FORMICA COLORCORE

Apprx. Weight (same as above)

Table Size	Standard Height 29"	Counter Height 36"	Community Height 42"
30 x 72	10,534	10,789	11,272
30 x 84	10,976	11,266	12,856
30 x 96	12,009	12,300	12,891
36 x 72	10,740	10,981	11,501
36 x 84	11,212	11,489	13,116
36 x 96	12,246	12,523	13,151
42 x 72	11,144	11,362	11,931
42 x 84	12,673	12,988	13,605
42 x 96	12,709	13,023	13,652
48 x 72	12,161	12,378	12,946
48 x 84	12,692	13,006	14,619
48 x 96	13,726	14,040	14,655

Formica ColorCore

- 7223 New White
- 909 Black
- 961 Fog
- 927 Folkstone
- 923 Surf
- 845 Spectrum Red
- 932 Antique White
- 933 Mission White
- 949 White

Power Options Available:

- EXP2 (MHO)
- Axil Z
- Glenbeigh

SYNTECH™

MEETING AND CONFERENCE TABLES

- Includes Symmetrical legs
- Grade 3 powdercoat standard, Grade 1 laminate standard
- Wood Edges and Veneer are Maple Species (veneer is long grain)
- Oak Edges and Veneer are available at the same price, specify on order
- Several optional power solutions available, see Power Solutions Section
 - Grommets optional, see power solutions



25SS RECTANGLE



Wood Edges Only



Table Size	Bases	Base Size	13500 / 13333 / 1440	23000	24000 / 24022 / 24055	38350	Veneer Upcharge
30 x 60	2	22	1,013	1,207	1,257	1,395	511
30 x 72	2	22	1,218	1,447	1,508	1,675	614
30 x 84	2	22	1,419	1,688	1,759	1,953	716
30 x 96	2	22	1,621	1,928	2,008	2,231	819
30 x 120	3	22	2,029	2,410	2,512	2,789	1,024
36 x 60	2	22	1,217	1,446	1,508	1,673	614
36 x 72	2	22	1,460	1,737	1,811	2,008	736
36 x 84	2	22	1,704	2,027	2,110	2,345	860
36 x 96	2	22	1,947	2,316	2,410	2,677	983
36 x 120	3	22	2,432	2,894	3,013	3,347	1,227

25SS RACETRACK



Wood Edges Only

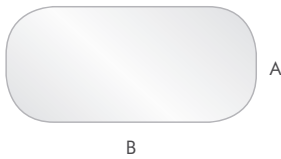

Table Size	Bases	Base Size	13500 / 13333 / 1440	23000	24000 / 24022 / 24055	38350	Veneer Upcharge
30 x 60	2	22	1,134	1,350	1,407	1,563	511
30 x 72	2	22	1,363	1,621	1,688	1,876	614
30 x 84	2	22	1,590	1,893	1,967	2,186	716
30 x 96	2	22	1,816	2,159	2,250	2,499	819
30 x 120	3	22	2,271	2,699	2,813	3,125	1,024
36 x 60	2	22	1,362	1,620	1,688	1,875	614
36 x 72	2	22	1,635	1,947	2,027	2,250	736
36 x 84	2	22	1,907	2,270	2,365	2,625	860
36 x 96	3	22	2,179	2,594	2,699	2,999	983
36 x 120	3	22	2,724	3,241	3,376	3,747	1,227

25MC MEDIA CONFERENCE



Wood Edges Only

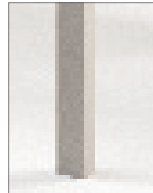

Table Size	Bases	Base Size	13500 / 13333 / 1440	23000	24000 / 24022 / 24055	38350	Veneer Upcharge
24 x 36 x 72	2	22	1,361	1,170	1,218	1,910	736
24 x 36 x 90	2	22	1,702	1,462	1,520	2,343	921
24 x 36 x 108	2	22	2,041	1,755	1,824	2,811	1,104
24 x 36 x 120	3	22	2,269	1,950	2,027	3,124	1,227

CURV™

MEETING AND CONFERENCE TABLES

- Available in three heights, with square or round columns, specify on order
- Grade 3 powdercoat, Grade 1 laminate standard
- Wood Edges and Veneer are Maple Species (veneer is long grain)
- Oak Edges and Veneer are available at the same price, specify on order
- Several optional power solutions available, see Power Solutions Section
 - Grommets optional, see power solutions
- Optional Wireway Leg



Available with square column



65CV-CT ROUND



Wood Edges Only

Table Size	Bases	Base Size	13500 / 13333 / 1440			24000 / 24055			38350			Veneer Upcharge	Polished Chrome Upcharge		
			29.5"	36"	42"	29.5"	36"	42"	29.5"	36"	42"		29.5"	36"	42"
42 Round	4	3"	948	1,134	1,226	1,506	1,693	1,784	1,379	1,565	1,657	502	165	175	211
48 Round	4	3"	1,004	1,189	1,282	1,695	1,881	1,973	1,528	1,713	1,807	655	165	175	211
60 Round	4	3"	1,169	1,355	1,447	1,827	2,012	2,105	1,683	1,869	1,960	1,024	165	175	211



65CV-CT SQUARE



Wood Edges Only

Table Size	Bases	Base Size	13500 / 13333 / 1440			24000 / 24055			38350			Veneer Upcharge	Polished Chrome Upcharge		
			29.5"	36"	42"	29.5"	36"	42"	29.5"	36"	42"		29.5"	36"	42"
42 Square	4	3"	901	1,087	1,179	1,431	1,618	1,710	1,310	1,496	1,589	502	165	175	211
48 Square	4	3"	954	1,140	1,232	1,609	1,796	1,888	1,450	1,638	1,729	655	165	175	211
60 Square	4	3"	1,111	1,297	1,390	1,736	1,922	2,014	1,599	1,784	1,877	1,024	165	175	211

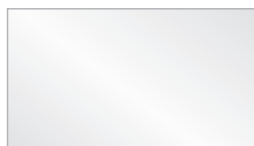

65CV-CT RECTANGULAR



Wood Edges Only

Table Size	Bases	Base Size	13500 / 13333 / 1440			24000 / 24055			38350			Veneer Upcharge	Polished Chrome Upcharge		
			29.5"	36"	42"	29.5"	36"	42"	29.5"	36"	42"		29.5"	36"	42"
36 x 60	4	3"	992	1,178	1,270	1,369	1,555	1,648	1,418	1,604	1,696	614	165	175	211
36 x 72	4	3"	1,084	1,270	1,362	1,506	1,693	1,784	1,582	1,768	1,861	736	165	175	211

CURV™

MEETING AND CONFERENCE TABLES

- Available in three heights, with square or round columns, specify on order
- Grade 3 powdercoat, Grade 1 laminate standard
- Wood Edges and Veneer are Maple Species (veneer is long grain)
- Oak Edges and Veneer are available at the same price, specify on order
- Several optional power solutions available, see Power Solutions Section
 - Grommets optional, see power solutions
- Optional Wireway Leg

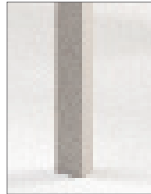

Available with square columns



65CV-CT CONFERENCE



Wood Edges Only

Table Size (A x C x B)	Bases	Base Size	13500 / 13333 / 1440			24000 / 24055			38350			Veneer Upcharge		Polished Chrome Upcharge		
			29.5"	36"	42"	29.5"	36"	42"	29.5"	36"	42"	29.5"	36"	42"		
36 x 72 x 48	4	3"	1,534	1,721	1,813	1,740	1,927	2,018	1,834	2,020	2,113	983	165	175	211	
36 x 90 x 48	4	3"	1,656	1,843	1,936	1,916	2,102	2,194	2,036	2,221	2,314	1,227	165	175	211	
36 x 108 x 48	6	3"	2,224	2,504	2,643	2,535	2,816	2,953	2,677	2,956	3,095	1,474	243	258	310	
36 x 120 x 48	6	3"	2,305	2,584	2,723	2,651	2,930	3,070	2,810	3,089	3,227	1,638	243	258	310	



65CV-WA WAVE



Wood Edges Only

Table Size	Bases	Base Size	13500 / 13333 / 1440			15300			Veneer Upcharge	Polished Chrome Upcharge		
			29.5"	36"	42"	29.5"	36"	42"		29.5"	36"	42"
36 x 58	4	3"	1,131	1,318	1,409	1,339	1,527	1,618	696	165	175	211

J91CT

MEETING AND CONFERENCE TABLES

- Grade 3 powdercoat, Grade 1 laminate standard
- Wood Edges and Veneer are Maple Species (veneer is long grain)
- Oak Edges and Veneer are available at the same price, specify on order
- Several optional power solutions available, see Power Solutions Section
 - Grommets optional, see power solutions



J91CT ROUND



Table Size	Bases	Base Size	1333	1344	2400 / 2405 / 3810	2600 / 2605	Veneer Upcharge	Polished Chrome Upcharge
42 Round	1	22"	1,135	1,153	1,640	1,847	502	175
48 Round	1	26"	1,359	1,379	1,939	2,178	655	211



J91CT SQUARE



Table Size	Bases	Base Size	1333	1344	2400 / 2405 / 3810	2600 / 2605	Veneer Upcharge	Polished Chrome Upcharge
42 Square	1	22"	1,178	1,198	1,521	1,698	502	175
48 Square	1	26"	1,407	1,430	1,755	1,949	655	211

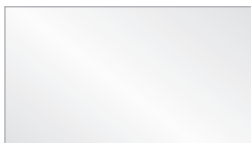

J91CT RECTANGULAR



Table Size	Bases	Base Size	1333	1344	2400 / 2405 / 3810	2600 / 2605	Veneer Upcharge	Polished Chrome Upcharge
36 x 72	2	22"	2,172	2,199	2,386	2,576	736	350
36 x 84	2	22"	2,234	2,267	2,589	2,827	860	350
36 x 96	2	22"	2,236	2,269	2,596	2,837	983	350
36 x 120	3	22"	2,383	2,423	2,835	3,138	1,227	525
36 x 144	3	22"	3,349	3,397	3,893	4,256	1,474	525
42 x 72	2	26"	2,798	2,840	3,272	3,601	860	421
42 x 84	2	26"	2,854	2,900	3,290	3,622	1,003	421
42 x 96	2	26"	2,909	2,958	3,300	3,635	1,146	421
42 x 120	3	26"	4,254	4,321	4,680	5,117	1,433	631
42 x 144	3	26"	4,513	4,597	5,043	5,572	1,720	631
48 x 72	2	26"	2,487	2,514	3,152	3,450	983	421
48 x 84	2	26"	2,909	2,958	3,316	3,656	1,146	421
48 x 96	2	26"	2,975	3,030	3,334	3,679	1,310	421
48 x 120	3	26"	4,333	4,406	4,761	5,217	1,638	631
48 x 144	3	26"	4,462	4,541	5,140	5,692	1,964	631

Note: 144" Ships in 2 pieces

J91CT

MEETING AND CONFERENCE TABLES

- Grade 3 powdercoat, Grade 1 laminate standard
- Wood Edges and Veneer are Maple Species (veneer is long grain)
- Oak Edges and Veneer are available at the same price, specify on order
- Several optional power solutions available, see Power Solutions Section
 - Grommets optional, see power solutions



J91CT RACETRACK



Table Size	Bases	Base Size	1333	1344	2400 / 2405 / 3810	2600 / 2605	Veneer Upcharge	Polished Chrome Upcharge
36 x 72	2	22"	2,198	2,227	2,426	2,626	736	350
36 x 84	2	22"	2,265	2,298	2,638	2,890	860	350
36 x 96	2	22"	2,268	2,302	2,647	2,901	983	350
36 x 120	3	22"	3,235	3,277	3,714	4,035	1,227	525
36 x 144	3	22"	3,395	3,444	3,968	4,351	1,474	525
42 x 72	2	26"	2,838	2,885	3,341	3,687	860	421
42 x 84	2	26"	2,898	2,947	3,359	3,710	1,003	421
42 x 96	2	26"	2,956	3,009	3,368	3,723	1,146	421
42 x 120	3	26"	4,319	4,390	4,771	5,229	1,433	631
42 x 144	3	26"	4,593	4,677	5,155	5,709	1,720	631
48 x 72	2	26"	2,512	2,542	3,216	3,530	983	421
48 x 84	2	26"	2,956	3,009	3,388	3,745	1,146	421
48 x 96	2	26"	3,027	3,082	3,405	3,769	1,310	421
48 x 120	3	26"	4,401	4,478	4,857	5,337	1,638	631
48 x 144	3	26"	4,537	4,621	5,257	5,835	1,964	631

Note: 144" Ships in 2 pieces

J91CT BOATSHAPE



Table Size	Bases	Base Size	1333	1344	2400 / 2405 / 3810	2600 / 2605	Veneer Upcharge	Polished Chrome Upcharge
36 x 72	2	22"	2,227	2,259	2,495	2,713	736	350
36 x 84	2	22"	2,298	2,333	2,724	2,999	860	350
36 x 96	2	22"	2,302	2,336	2,734	3,011	983	350
36 x 120	3	22"	3,277	3,321	3,824	4,170	1,227	525
36 x 144	3	22"	3,444	3,496	4,100	4,516	1,474	525
42 x 72	2	26"	2,885	2,933	3,461	3,836	860	421
42 x 84	2	26"	2,947	2,999	3,481	3,862	1,003	421
42 x 96	2	26"	3,009	3,063	3,490	3,874	1,146	421
42 x 120	3	26"	4,390	4,467	4,929	5,427	1,433	631
42 x 144	3	26"	4,677	4,770	5,347	5,950	1,720	631
48 x 72	2	26"	2,542	2,572	3,323	3,665	983	421
48 x 84	2	26"	3,009	3,063	3,510	3,901	1,146	421
48 x 96	2	26"	3,082	3,140	3,532	3,925	1,310	421
48 x 120	3	26"	4,478	4,559	5,022	5,544	1,638	631
48 x 144	3	26"	4,621	4,709	5,455	6,088	1,964	631

Note: 144" Ships in 2 pieces

J11CT

MEETING AND CONFERENCE TABLES

- Grade 3 powdercoat, Grade 1 laminate standard
- Wood Edges and Veneer are Maple Species (veneer is long grain)
- Oak Edges and Veneer are available at the same price, specify on order
- Several optional power solutions available, see Power Solutions Section
 - Grommets optional, see power solutions



J11CT ROUND



Table Size	Bases	Base Size	1333	1344	2400 / 2405 /3810	2600 / 2605	Veneer Upcharge	Polished Chrome Upcharge
42 Round	1	22"	893	909	1,396	1,603	502	241
48 Round	1	26"	1,015	1,036	1,596	1,834	655	273



J11CT SQUARE



Table Size	Bases	Base Size	1333	1344	2400 / 2405 /3810	2600 / 2605	Veneer Upcharge	Polished Chrome Upcharge
42 Square	1	22"	936	953	1,277	1,454	502	241
48 Square	1	26"	1,064	1,087	1,410	1,605	655	273

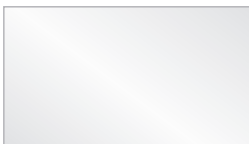

J11CT RECTANGULAR



Table Size	Bases	Base Size	1333	1344	2400 / 2405 /3810	2600 / 2605	Veneer Upcharge	Polished Chrome Upcharge
36 x 72	2	22"	1,684	1,712	1,900	2,090	736	483
36 x 84	2	22"	1,748	1,779	2,099	2,339	860	483
36 x 96	2	22"	1,752	1,781	2,107	2,350	983	483
36 x 120	3	22"	2,469	2,508	2,921	3,223	1,227	724
36 x 144	3	22"	2,618	2,666	3,162	3,526	1,474	724
42 x 72	2	26"	2,112	2,156	2,589	2,916	860	546
42 x 84	2	26"	2,169	2,216	2,604	2,938	1,003	546
42 x 96	2	26"	2,225	2,273	2,613	2,948	1,146	546
42 x 120	3	26"	3,225	3,293	3,652	4,089	1,433	819
42 x 144	3	26"	3,486	3,568	4,014	4,543	1,720	819
48 x 72	2	26"	1,802	1,829	2,467	2,766	983	546
48 x 84	2	26"	2,225	2,273	2,630	2,972	1,146	546
48 x 96	2	26"	2,289	2,343	2,649	2,994	1,310	546
48 x 120	3	26"	3,306	3,378	3,733	4,189	1,638	819
48 x 144	3	26"	3,435	3,513	4,112	4,664	1,964	819

Note: 144" Ships in 2 pieces

J11CT

MEETING AND CONFERENCE TABLES

- Grade 3 powdercoat, Grade 1 laminate standard
- Wood Edges and Veneer are Maple Species (veneer is long grain)
- Oak Edges and Veneer are available at the same price, specify on order
- Several optional power solutions available, see Power Solutions Section
 - Grommets optional, see power solutions



J11CT RACETRACK



Table Size	Bases	Base Size	1333	1344	2400 / 2405 / 3810	2600 / 2605	Veneer Upcharge	Polished Chrome Upcharge
36 x 72	2	22"	1,711	1,739	1,940	2,140	736	483
36 x 84	2	22"	1,777	1,812	2,149	2,403	860	483
36 x 96	2	22"	1,780	1,815	2,159	2,416	983	483
36 x 120	3	22"	2,506	2,548	2,984	3,304	1,227	724
36 x 144	3	22"	2,664	2,713	3,236	3,621	1,474	724
42 x 72	2	26"	2,154	2,200	2,655	3,001	860	546
42 x 84	2	26"	2,213	2,263	2,672	3,026	1,003	546
42 x 96	2	26"	2,271	2,323	2,684	3,037	1,146	546
42 x 120	3	26"	3,291	3,362	3,742	4,202	1,433	819
42 x 144	3	26"	3,562	3,649	4,127	4,681	1,720	819
48 x 72	2	26"	1,827	1,857	2,530	2,843	983	546
48 x 84	2	26"	2,271	2,323	2,702	3,060	1,146	546
48 x 96	2	26"	2,339	2,395	2,721	3,084	1,310	546
48 x 120	3	26"	3,374	3,450	3,828	4,309	1,638	819
48 x 144	3	26"	3,509	3,594	4,228	4,809	1,964	819

Note: 144" Ships in 2 pieces

J11CT BOATSHAPE



Table Size	Bases	Base Size	1333	1344	2400 / 2405 / 3810	2600 / 2605	Veneer Upcharge	Polished Chrome Upcharge
36 x 72	2	22"	1,739	1,772	2,007	2,226	736	483
36 x 84	2	22"	1,812	1,846	2,236	2,512	860	483
36 x 96	2	22"	1,815	1,850	2,247	2,525	983	483
36 x 120	3	22"	2,548	2,592	3,094	3,440	1,227	724
36 x 144	3	22"	2,713	2,766	3,369	3,785	1,474	724
42 x 72	2	26"	2,200	2,248	2,776	3,152	860	546
42 x 84	2	26"	2,263	2,315	2,793	3,175	1,003	546
42 x 96	2	26"	2,323	2,378	2,806	3,189	1,146	546
42 x 120	3	26"	3,362	3,439	3,902	4,399	1,433	819
42 x 144	3	26"	3,649	3,741	4,319	4,922	1,720	819
48 x 72	2	26"	1,857	1,885	2,639	2,981	983	546
48 x 84	2	26"	2,323	2,378	2,826	3,216	1,146	546
48 x 96	2	26"	2,395	2,455	2,845	3,241	1,310	546
48 x 120	3	26"	3,450	3,532	3,995	4,516	1,638	819
48 x 144	3	26"	3,594	3,681	4,428	5,059	1,964	819

Note: 144" Ships in 2 pieces

24CT/24VT

MEETING AND CONFERENCE TABLES

- 24CT, Grade 3 powdercoat, Grade 1 laminate standard
- 24VT, Long Grain Maple Veneer, standard wood finish
- Optional Oak Species Edges and Veneer, available same price, order must specify
- Several optional power solutions available, see Power Solutions section
 - Grommets optional, see power solutions



24CT/24VT ROUND



Table Size	Bases	Base Size	24CT 1300	24CT 1344	24CT 2400 / 2405	24CT 2600 / 2605	24VT Veneer Upcharge	Polished Chrome Upcharge
36 Round	1	22	720	806	1,621	1,817	368	104
42 Round	1	28	883	964	1,863	2,107	502	123
48 Round	1	36	1,094	1,173	2,151	2,380	655	151
54 Round	1	5-36	1,325	1,417	2,672	3,048	829	299
60 Round	1	5-36	1,372	1,476	2,709	3,085	1,024	299

5-36 = 5 column 36" X base

24CT/24VT SQUARE



Table Size	Bases	Base Size	24CT 1300	24CT 1344	24CT 2400 / 2405	24CT 2600 / 2605	24VT Veneer Upcharge	Polished Chrome Upcharge
36 Square	1	28	718	794	1,233	1,516	368	123
42 Square	1	36	1,043	1,119	1,626	1,861	502	151
48 Square	1	5-36	1,062	1,147	1,772	2,061	655	299
54 Square	1	5-36	1,825	1,928	2,666	2,976	829	299
60 Square	1	5-36	1,876	1,981	2,702	3,014	1,024	299

5-36 = 5 column 36" X base

24CT/24VT RECTANGULAR



Tables 36" wide include single column end bases. Tables wider than 36" include double column end bases.

Tables 144" or longer ship in two pieces.

Table Size	Bases	Base Size	24CT 1300	24CT 1344	24CT 2400 / 2405	24CT 2600 / 2605	24VT Veneer Upcharge	Polished Chrome Upcharge
36 x 60	2	22	941	1,021	1,736	2,025	511	143
36 x 72	2	22	1,116	1,170	1,753	2,052	736	143
36 x 84	2	22	1,309	1,453	2,140	2,471	860	143
36 x 96	2	22	1,314	1,463	2,159	2,477	983	143
42 x 72	2	32	1,808	1,914	2,901	3,232	860	336
42 x 84	2	32	1,929	2,050	2,942	3,272	1,003	336
42 x 96	2	32	2,050	2,192	2,961	3,291	1,146	336
42 x 108	2	32	2,175	2,332	2,999	3,367	1,289	336
42 x 120	3	32	2,833	3,007	3,802	4,154	1,433	505
48 x 84	2	32	2,050	2,192	2,999	3,329	1,146	336
48 x 96	2	32	2,192	2,351	3,038	3,367	1,310	336
48 x 108	3	32	2,871	3,048	3,817	4,178	1,474	505
48 x 120	3	32	3,007	3,210	3,973	4,332	1,638	505
48 x 144	3	32	3,288	3,526	4,815	4,809	1,964	505
60 x 120	3	32	3,842	4,108	4,572	4,942	2,046	505
60 x 144	3	32	4,307	4,611	5,368	5,567	2,455	505
60 x 168	3	32	5,143	5,537	6,288	7,218	2,865	505
60 x 192	4	32	6,066	6,523	7,178	7,956	3,274	673

24CT/24VT

MEETING AND CONFERENCE TABLES

- 24CT, Grade 3 powdercoat, Grade 1 laminate standard
- 24VT, Long Grain Maple Veneer, standard wood finish
- Optional Oak Species Edges and Veneer, available same price, order must specify
- Several optional power solutions available, see Power Solutions section
 - Grommets optional, see power solutions



24CT/24VT
RACETRACK



Wood Edges Only

Table Size	Bases	Base Size	24CT 1300	24CT 1344	24CT 2400 / 2405	24CT 2600 / 2605	24VT Veneer Upcharge	Polished Chrome Upcharge
36 x 60	2	22	986	1,074	2,140	2,546	511	143
36 x 72	2	22	1,074	1,177	2,171	2,566	736	143
36 x 84	2	22	1,244	1,549	2,686	3,110	860	143
36 x 96	2	22	1,396	1,558	2,713	3,129	983	143
42 x 72	2	32	1,880	1,997	3,515	3,901	860	336
42 x 84	2	32	2,014	2,147	3,560	4,001	1,003	336
42 x 96	2	32	2,147	2,304	3,571	4,029	1,146	336
42 x 108	2	32	2,286	2,460	3,640	4,114	1,289	336
42 x 120	3	32	2,953	3,148	4,516	5,001	1,433	505
48 x 84	2	32	2,147	2,304	3,640	4,074	1,146	336
48 x 96	2	32	2,304	2,480	3,685	4,114	1,310	336
48 x 108	3	32	2,995	3,193	4,555	5,030	1,474	505
48 x 120	3	32	3,148	3,373	4,748	5,263	1,638	505
48 x 144	3	32	3,455	3,720	5,745	6,247	1,964	505
60 x 120	3	32	4,085	4,360	5,550	6,046	2,046	505
60 x 144	3	32	4,577	4,910	6,685	7,306	2,455	505
60 x 168	3	32	5,499	5,929	7,849	9,089	2,865	505
60 x 192	4	32	6,465	6,966	8,848	9,911	3,274	673

Tables 36" wide include single column end bases. Tables wider than 36" include double column end bases. Tables 144" or longer ship in two pieces.

24CT/24VT
BOATSHAPE



Wood Edges Only

Table Size	Bases	Base Size	24CT 1300	24CT 1344	24CT 2400 / 2405	24CT 2600 / 2605	24VT Veneer Upcharge	Polished Chrome Upcharge
33 x 42 x 96	2	32	1,998	2,209	3,779	4,310	1,146	336
36 x 48 x 120	3	32	2,993	3,220	4,996	5,547	1,638	505
36 x 48 x 144	3	32	3,312	3,589	6,148	6,722	1,964	505
48 x 60 x 144	3	32	4,707	5,057	7,451	8,157	2,455	505
48 x 60 x 168	3	32	5,672	6,129	8,875	10,135	2,865	505
48 x 60 x 192	4	32	6,662	7,188	9,861	11,093	3,274	673

Tables include double column end bases. Tables 144" or longer ship in two pieces.

31CT/31VT

MEETING AND CONFERENCE TABLES

- 31CT, Grade 1 Laminate Standard Wood Finish
- 31VT, Long Grain Maple Veneer, Standard Wood Finish
- Optional Oak Edges and Long Grain Veneer, same price, order must specify
- Several optional power solutions available, see Power Solutions section
 - Grommets optional, see power solutions

31CT/31VT ROUND

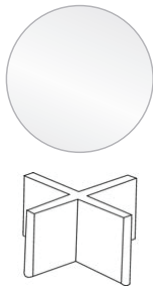

Table Size	Bases	31CT 1300	31CT 1344	31CT 2400 / 2405	31VT 2400 / 2405	31CT 2600 / 2605	31VT 2600 / 2605
36 Round	1	3,507	3,586	4,446	7,593	4,650	8,034
42 Round	1	3,673	3,758	4,700	7,855	4,956	8,630
48 Round	1	3,714	3,800	4,825	8,651	5,064	9,119
54 Round	1	3,960	4,057	5,372	10,697	5,769	10,971
60 Round	1	4,006	4,118	5,410	11,067	5,808	11,350

Panel Base

31CT/31VT SQUARE

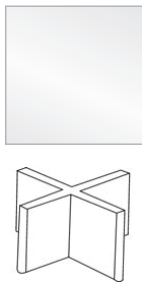

Table Size	Bases	31CT 1300	31CT 1344	31CT 2400 / 2405	31VT 2400 / 2405	31CT 2600 / 2605	31VT 2600 / 2605
36 Square	1	3,505	3,583	4,041	6,428	4,337	6,693
42 Square	1	3,665	3,742	4,323	7,094	4,568	7,362
48 Square	1	3,685	3,771	4,427	7,376	4,733	8,334
54 Square	1	3,957	4,059	4,834	9,864	5,158	10,370
60 Square	1	4,005	4,117	4,872	10,189	5,196	10,720

Panel Base

31CT/31VT RECTANGULAR



Table Size	Bases	31CT 1300	31CT 1344	31CT 2400 / 2405	31VT 2400 / 2405	31CT 2600 / 2605	31VT 2600 / 2605
36 x 60	2	2,248	2,331	3,074	7,125	3,380	7,366
36 x 72	2	2,331	2,430	3,098	7,427	3,413	7,657
36 x 84	2	2,635	2,635	3,505	7,721	3,850	7,949
36 x 96	2	2,641	2,641	3,522	8,362	3,857	8,551
42 x 72	2	2,557	2,668	3,709	7,770	4,051	8,088
42 x 84	2	2,682	2,812	3,745	8,362	4,092	8,551
42 x 96	2	2,812	2,961	3,767	8,688	4,114	8,917
42 x 108	2	2,943	3,105	3,810	9,277	4,194	9,516
42 x 120	3	3,946	4,128	4,960	11,649	5,332	11,917
48 x 84	2	2,812	2,961	3,810	8,561	4,152	8,826
48 x 96	2	2,961	3,126	3,847	9,303	4,194	9,532
48 x 108	2	3,105	3,294	4,101	9,773	4,475	10,002
48 x 120	3	4,128	4,339	5,142	12,359	5,515	12,645
48 x 144	3	4,423	4,671	6,023	14,262	6,014	14,585
60 x 120	3	5,020	5,283	5,770	15,860	6,156	16,493
60 x 144	3	5,489	5,808	6,603	17,465	6,816	17,876
60 x 168	3	6,383	6,797	7,582	19,015	8,560	19,529
60 x 192	4	6,857	7,332	8,913	24,246	9,727	24,840

- Panel Base
- Tables 144" or longer ship in two pieces.

31CT/31VT

MEETING AND CONFERENCE TABLES

- 31CT, Grade 1 Laminate Standard Wood Finish
- 31VT, Long Grain Maple Veneer, Standard Wood Finish
- Optional Oak Edges and Long Grain Veneer, same price, order must specify
- Several optional power solutions available, see Power Solutions section
 - Grommets optional, see power solutions

31CT/31VT RACETRACK



Table Size	Bases	31CT 1300	31CT 1344	31CT 2400 / 2405	31VT 2400 / 2405	31CT 2600 / 2605	31VT 2600 / 2605
36 x 60	2	2,293	2,389	3,505	8,149	3,927	8,910
36 x 72	2	2,389	2,493	3,534	8,573	3,951	9,169
36 x 84	2	2,716	2,716	4,072	9,346	4,517	9,668
36 x 96	2	2,726	2,726	4,101	9,795	4,536	9,975
42 x 72	2	2,637	2,756	4,346	9,346	4,756	9,668
42 x 84	2	2,775	2,918	4,394	9,795	4,855	9,979
42 x 96	2	2,918	3,077	4,405	10,276	4,883	10,490
42 x 108	2	3,057	3,239	4,475	10,818	4,974	11,013
42 x 120	3	4,074	4,274	5,708	13,175	6,218	13,599
48 x 84	2	2,918	3,077	4,475	10,370	4,934	10,179
48 x 96	2	3,077	3,260	4,531	10,900	4,974	11,227
48 x 108	2	3,239	3,446	4,872	12,313	5,372	11,757
48 x 120	3	4,274	4,509	5,953	14,262	6,462	14,573
48 x 144	3	4,599	4,872	6,996	16,065	7,525	16,650
60 x 120	3	5,256	5,544	6,795	17,516	7,513	17,975
60 x 144	3	5,772	6,121	7,983	19,639	8,634	22,520
60 x 168	3	6,756	7,210	9,128	21,386	10,522	24,710
60 x 192	4	7,272	7,800	10,662	26,792	11,777	28,775

- Panel Base
- Tables 144" or longer ship in two pieces.

31CT/31VT BOATSHAPE



Table Size	Bases	31CT 1300	31CT 1344	31CT 2400 / 2405	31VT 2400 / 2405	31CT 2600 / 2605	31VT 2600 / 2605
33 x 42 x 96	2	2,965	3,137	4,780	10,599	5,339	10,825
36 x 48 x 120	3	3,473	3,716	6,449	14,686	7,028	15,014
36 x 48 x 144	3	3,811	4,100	7,657	16,585	8,254	17,197
48 x 60 x 144	3	5,039	5,400	8,785	20,320	9,528	23,347
48 x 60 x 168	3	6,938	7,414	10,295	22,155	11,614	25,650
48 x 60 x 192	4	7,481	8,030	11,728	27,647	13,015	29,734

- Panel Base
- Tables 144" or longer ship in two pieces.

51CT/51VT

MEETING AND CONFERENCE TABLES

- 51CT, Grade 1 Laminate Standard Wood Finish
- 51VT, Long Grain Maple Veneer, Standard Wood Finish
- Optional Oak Edges and Long Grain Veneer, same price, order must specify
- Several optional power solutions available, see Power Solutions section
 - Grommets optional, see power solutions

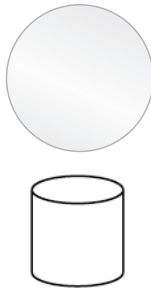

51CT/51VT ROUND



Table Size	Bases	51CT 1300	51CT 1344	51CT 2400 / 2405	51VT 2400 / 2405	51CT 2600 / 2605	51VT 2600 / 2605
36 Round	1	1,332	1,415	2,271	5,056	2,477	5,495
42 Round	1	1,727	1,808	2,752	5,544	3,005	6,316
48 Round	1	1,766	1,850	2,871	6,340	3,119	6,811
54 Round	1	2,417	2,513	3,829	8,891	4,224	9,162
60 Round	1	2,465	2,573	3,869	9,259	4,264	9,544

Drum Base



51CT/51VT SQUARE



Table Size	Bases	51CT 1300	51CT 1344	51CT 2400 / 2405	51VT 2400 / 2405	51CT 2600 / 2605	51VT 2600 / 2605
36 Square	1	1,330	1,408	1,868	3,891	2,164	4,154
42 Square	1	1,714	1,794	2,375	4,783	2,618	5,051
48 Square	1	1,735	1,824	2,477	5,062	2,782	6,020
54 Square	1	2,412	2,515	3,290	8,053	3,615	8,563
60 Square	1	2,462	2,572	3,329	8,380	3,654	8,912

Drum Base

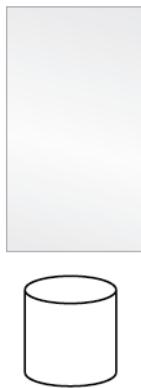

51CT/51VT RECTANGULAR



Table Size	Bases	51CT 1300	51CT 1344	51CT 2400 / 2405	51VT 2400 / 2405	51CT 2600 / 2605	51VT 2600 / 2605
36 x 60	2	2,612	2,698	3,443	5,089	3,754	5,932
36 x 72	2	2,698	2,796	3,461	5,995	3,776	6,227
36 x 84	2	2,999	2,999	3,869	6,291	4,217	6,519
36 x 96	2	3,005	3,005	3,890	6,930	4,224	7,120
42 x 72	2	3,210	3,319	4,356	6,794	4,700	7,109
42 x 84	2	3,335	3,461	4,394	7,386	4,740	7,577
42 x 96	2	3,461	3,608	4,421	7,708	4,761	7,945
42 x 108	2	3,590	3,758	4,455	8,302	4,840	8,543
42 x 120	2	3,723	3,903	4,733	8,800	5,105	9,063
48 x 84	2	3,626	3,771	4,620	8,800	4,715	7,853
48 x 96	2	3,771	3,938	4,658	8,325	5,004	8,557
48 x 108	2	3,920	4,107	4,915	8,800	5,288	9,026
48 x 120	2	4,061	4,276	5,079	9,512	5,451	9,794
48 x 144	2	4,358	4,607	5,962	11,409	5,952	11,735
60 x 120	2	5,770	6,032	6,519	13,773	6,902	14,405
60 x 144	2	6,237	6,555	7,350	15,376	7,564	15,788
60 x 168	2	7,115	7,530	8,315	18,816	9,291	17,799
60 x 192	3	9,292	9,767	10,458	20,467	11,268	21,064

- 5100 Series Drum Base
- Tables 144" or longer ship in two pieces.

51CT/51VT

MEETING AND CONFERENCE TABLES

- 51CT, Grade 1 Laminate Standard Wood Finish
- 51VT, Long Grain Maple Veneer, Standard Wood Finish
- Optional Oak Edges and Long Grain Veneer, same price, order must specify
- Several optional power solutions available, see Power Solutions section
 - Grommets optional, see power solutions



51CT/51VT RACETRACK

Table Size	Bases	51CT 1300	51CT 1344	51CT 2400 / 2405	51VT 2400 / 2405	51CT 2600 / 2605	51VT 2600 / 2605
36 x 60	2	2,659	2,752	3,869	6,719	4,293	7,479
36 x 72	2	2,752	2,861	3,899	7,147	4,316	7,741
36 x 84	2	3,083	3,083	4,440	7,914	4,883	8,237
36 x 96	2	3,091	3,091	4,467	8,364	4,903	8,547
42 x 72	2	3,280	3,404	4,995	8,368	5,400	8,692
42 x 84	2	3,425	3,565	5,048	8,820	5,503	9,003
42 x 96	2	3,565	3,730	5,057	9,303	5,535	9,516
42 x 108	2	3,710	3,890	5,128	9,839	5,624	10,040
42 x 120	2	3,847	4,050	5,483	10,325	5,991	10,750
48 x 84	2	3,730	3,891	5,288	9,396	5,747	9,207
48 x 96	2	3,891	4,073	5,339	9,928	5,786	10,252
48 x 108	2	4,051	4,259	5,687	11,339	6,182	10,781
48 x 120	2	4,212	4,445	5,886	11,409	6,397	11,723
48 x 144	2	4,534	4,811	6,933	13,214	7,463	13,798
60 x 120	2	6,002	6,293	7,543	15,424	8,057	15,882
60 x 144	2	6,521	6,870	8,731	17,546	9,381	20,390
60 x 168	2	7,486	7,943	9,952	21,188	11,251	24,507
60 x 192	3	9,707	10,234	12,202	23,015	13,320	24,996

- 5100 Series Drum Base
- Tables 144" or longer ship in two pieces.

51CT/51VT BOATSHAPE



Table Size	Bases	51CT 1300	51CT 1344	51CT 2400 / 2405	51VT 2400 / 2405	51CT 2600 / 2605	51VT 2600 / 2605
33 x 42 x 96	2	3,618	3,786	5,435	9,624	5,991	9,848
36 x 48 x 120	2	4,285	4,531	6,384	11,837	6,966	12,169
36 x 48 x 144	2	4,624	4,910	7,594	13,731	8,191	14,346
48 x 60 x 144	2	6,662	6,966	9,473	18,233	10,214	21,220
48 x 60 x 168	2	7,671	8,088	10,964	21,955	12,282	25,446
48 x 60 x 192	3	9,918	10,468	13,270	23,877	14,559	25,959

- 5100 Series Drum Base
- Tables 144" or longer ship in two pieces.

MEETING AND CONFERENCE TABLES

- Grade 3 Powdercoat, Grade 1 Laminate, Standard Wood Finish
- Wood Edges and Veneer are Maple Species (veneer is long grain)
- Oak Edges and Veneer are available at the same price, specify on order
- Several optional power solutions available, see Power Solutions Section
 - Grommets optional, see power solutions

ST3X ROUND PEDESTAL BASE



Table Size	Bases	Base Size	1300 / 1333 1340 / 1440	1444 / 2323	2405 / 2420	2344	4150	Veneer Upcharge	Polished Chrome Upcharge	Welded Base Upcharge
30 Round	1	26S	711	866	1,417	1,007	N/A	257	116	51
36 Round	1	26S	759	945	1,515	1,082	N/A	368	116	51
42 Round	1	32S-3	954	1,186	1,757	1,331	N/A	502	116	51
48 Round	1	32S-3	974	1,228	1,817	1,372	2,238	655	116	51
54 Round	1	38Q	1,405	1,736	2,676	1,878	N/A	829	173	N/A
60 Round	1	38Q	1,419	1,778	2,708	1,921	3,156	1,024	173	N/A

• ST3X- Pedestal Base

ST3X SQUARE PEDESTAL BASE

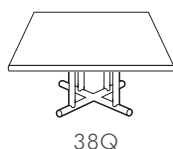
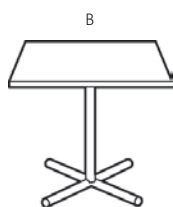

Table Size A x B	Bases	Base Size	1300 / 1333 1340 / 1440	1444 / 2323	2405 / 2420	2344	Veneer Upcharge	Polished Chrome Upcharge	Welded Base Upcharge
30 x 30	1	26S	683	801	1,071	945	257	116	51
36 x 36	1	32S-3	780	904	1,210	1,046	368	116	51
42 x 42	1	32S-3	911	1,090	1,458	1,228	502	116	51
48 x 48	1	38Q	1,144	1,336	1,760	1,476	655	173	N/A
54 x 54	1	38Q	1,381	1,736	2,127	1,878	829	173	N/A
60 x 60	1	38Q	1,447	1,778	2,295	1,921	1,024	173	N/A

• ST3X- Pedestal Base

ST3X RECTANGULAR PEDESTAL BASE

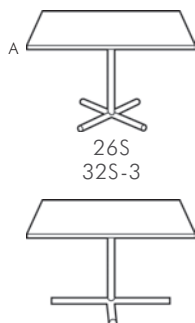

Table Size A x B x C	Bases	Base Size	1300 / 1333 1340 / 1440	1444 / 2323	2405 / 2420	2344	Veneer Upcharge	Polished Chrome Upcharge	Welded Base Upcharge
24 x 30	1	26S	651	765	1,012	905	206	116	51
24 x 36	1	26S	683	796	1,071	936	245	116	51
30 x 36	1	32S-3	734	864	1,154	1,006	308	116	51
30 x 48	1	38M-3	824	963	1,290	1,106	408	173	51
36 x 48	1	38M-3	887	1,056	1,388	1,199	491	173	51

• ST3X- Pedestal Base

ST3T/ST3C

MEETING AND CONFERENCE TABLES

- Grade 3 Powdercoat Grade 1 Laminate Standard Wood Finish
- Wood Edges and Veneer are Maple Species (veneer is long grain)
- Oak Edges and Veneer are available at the same price, specify on order
- Several optional power solutions available, see Power Solutions Section
 - Grommets optional, see power solutions

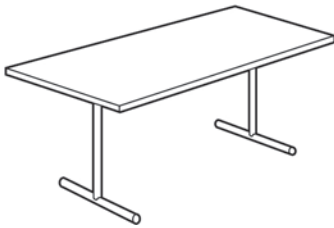

ST3T / ST3C
RECTANGULAR



Table Size A x B	Bases	Base Size	1300 / 1333 1340 / 1440	1444 / 2323	2405 / 2420	2344	4720	4150	Veneer Upcharge	Polished Chrome Upcharge	Welded Base Upcharge
18 x 48	1	14T or C	708	787	1,092	927	844	1,203	245	116	51
18 x 60	1	14T or C	729	877	1,203	1,018	924	1,300	308	116	51
18 x 72	1	14T or C	770	927	1,294	1,069	1,011	1,460	368	116	51
18 x 90	1	14T or C	1,105	1,324	1,953	1,464	1,452	N/A	460	116	51
24 x 48	1	18T or C	720	876	1,193	1,018	858	1,217	328	116	51
24 x 60	1	18T or C	778	968	1,337	1,111	973	1,313	408	116	51
24 x 72	1	18T or C	855	1,046	1,456	1,186	1,097	1,474	491	116	51
24 x 90	1	18T or C	1,202	1,444	2,038	1,585	1,549	N/A	614	116	51
30 x 48	1	24T	772	916	1,240	1,057	940	1,411	408	116	51
30 x 60	1	24T	866	1,049	1,439	1,189	1,083	1,545	511	116	51
30 x 72	1	24T	922	1,119	1,557	1,262	1,181	1,765	614	116	51
30 x 90	1	24T	1,373	1,499	2,119	1,643	1,765	N/A	768	116	51
36 x 48	1	24T	837	1,008	1,340	1,150	1,027	1,497	491	116	51
36 x 60	1	24T	907	1,108	1,588	1,245	1,170	1,765	614	116	51
36 x 72	1	24T	979	1,156	1,707	1,297	1,291	1,957	736	116	51
36 x 90	1	24T	1,447	1,692	2,236	1,833	1,936	N/A	921	116	51
42 x 84	1	32TT	1,687	1,764	2,463	1,906	2,338	N/A	1,003	173	51
42 x 96	1	32TT	1,697	1,809	2,626	1,948	2,349	N/A	1,146	173	51
48 x 96	1	38TT	1,744	1,868	2,671	2,006	N/A	N/A	1,310	173	51
48 x 120	3	38TT	2,184	2,355	3,247	2,496	N/A	N/A	1,638	229	51
48 x 144*	3	38TT	2,348	2,562	3,537	2,702	N/A	N/A	1,964	229	51
60 x 120	3	38TT	2,364	2,562	3,481	2,702	N/A	N/A	2,046	229	51
60 x 144*	3	38TT	2,555	2,799	3,797	2,942	N/A	N/A	2,455	229	51

- Tables 144" or longer ship in two pieces
- ST3T- Symmetrical end base, one column
- ST3C- Cantilever end base, one column
- T = one column end base
- TT = two column end base
- First two numbers of base style represents base dimension

LEAN SERIES



FEATURES

- Grade 3 powdercoat
- Available in multiple heights:
24", 27", 30" & 36"

Group A



Group B



Group C



Top Size (inches)	24" OAH			27" & 30" OAH			36" OAH		
	Group A	Group B	Group C	Group A	Group B	Group C	Group A	Group B	Group C
42 RD	2,104	2,474	2,775	2,291	2,661	2,962	3,288	3,658	3,959
48 RD	2,175	2,543	2,856	2,362	2,730	3,043	3,359	3,727	4,040
60 RD	2,472	3,040	3,453	2,659	3,227	3,640	3,656	4,224	4,637
72 RD	2,628	3,310	3,806	2,815	3,497	3,993	3,812	4,494	4,990
42x42	2,082	2,210	2,439	2,270	2,397	2,627	3,266	3,394	3,624
48x48	2,152	2,259	2,526	2,339	2,447	2,714	3,336	3,443	3,710
36x60	2,215	2,507	2,599	2,402	2,694	2,786	3,399	3,691	3,783
36x72	2,324	2,670	2,781	2,511	2,858	2,968	3,508	3,854	3,965
36x84	2,429	2,834	2,963	2,616	3,021	3,151	3,613	4,018	4,147
36x96	2,535	2,997	3,145	2,722	3,185	3,333	3,719	4,181	4,329
42x60	2,303	2,643	2,750	2,490	2,831	2,937	3,487	3,517	3,934
42x72	2,429	2,834	2,963	2,616	3,021	3,151	3,613	4,018	4,147
42x84	2,552	3,024	3,175	2,740	3,212	3,363	3,736	4,208	4,359
42x96	2,675	3,216	3,388	2,863	3,403	3,575	3,860	4,400	4,572
48x60	2,390	2,779	2,902	2,577	2,966	3,089	3,574	3,963	4,086
48x72	2,535	2,997	3,144	2,722	3,185	3,332	3,719	4,181	4,328
48x84	2,675	3,215	3,388	2,863	3,402	3,575	3,860	4,399	4,572
48x96	2,816	3,433	3,631	3,004	3,620	3,818	4,000	4,617	4,815
36x60	2,260	2,578	2,678	2,448	2,766	2,865	3,444	3,762	3,862
36x72	2,378	2,755	2,876	2,566	2,943	3,064	3,562	3,939	4,060
36x84	2,493	2,933	3,074	2,681	3,121	3,261	3,677	4,117	4,258
36x96	2,608	3,111	3,272	2,796	3,299	3,459	3,792	4,295	4,456
42x60	2,356	2,726	2,842	2,543	2,914	3,029	3,540	3,910	4,026
42x72	2,493	2,933	3,074	2,681	3,121	3,261	3,677	4,117	4,258
42x84	2,627	3,140	3,305	2,814	3,328	3,492	3,811	4,324	4,489
42x96	2,761	3,348	3,536	2,949	3,536	3,723	3,945	4,532	4,720
48x60	2,451	2,873	3,008	2,638	3,060	3,195	3,635	4,057	4,192
48x72	2,608	3,111	3,271	2,796	3,299	3,458	3,792	4,295	4,455
48x84	2,761	3,347	3,536	2,949	3,535	3,723	3,945	4,531	4,720
48x96	2,915	3,584	3,799	3,102	3,772	3,987	4,099	4,768	4,984
36x72x48	N/A	N/A	N/A	3,411	3,896	3,991	4,408	4,892	4,988
36x90x48	N/A	N/A	N/A	3,533	4,072	4,192	4,530	5,068	5,188

Racetrack

Video

Small Order Charge: Orders with a combined Net price under \$1,000 will be subject to a Special Handling Charge of \$125 Net. One charge per order.

TABLE TOP EDGE PROFILES
SYNTECH™



13500 1.25" fluted vinyl edge. High pressure laminate top standard with 3" radius corners. Available in a variety of colors



23000 1.25" x .25" wood banded edge high pressure laminate or veneer top surface



24055 1.25" x 1.25" full bullnose wood edge high pressure laminate, veneer, or Veneer Art top surface



13333 1.25" solid vinyl flat T mold edge. High pressure laminate top standard with 1" radius corners. Available in a variety of colors



24000 1.25" x 1.25" square wood edge high pressure laminate, veneer, or Veneer Art top surface



38350 1.25" x 2" beveled wood edge with high pressure laminate, veneer, or Veneer Art top surface.



1440 1.25 flat PVC edge band. High pressure laminate. Radius corners not available



24022 1.25" x 1.25" half bullnose wood edge high pressure laminate, veneer, or Veneer Art top surface

CURV™



13500 1.25" fluted vinyl edge. High pressure laminate top standard with 3" radius corners. Available in a variety of colors



24000 1.25" x 1.25" square wood edge high pressure laminate, veneer, or Veneer Art top surface



15300 1.25" 21-ply plywood reverse knife edge high pressure laminate top surface



13333 1.25" solid vinyl flat T mold edge. High pressure laminate top standard with 1" radius corners. Available in a variety of colors



24055 1.25" x 1.25" full bullnose wood edge high pressure laminate, veneer, or Veneer Art top surface



1440 1.25 flat PVC edge band. High pressure laminate. Radius corners not available



38350 1.25" x 2" beveled wood edge with high pressure laminate, veneer, or Veneer Art top surface.

TABLE TOP EDGE PROFILES

CONFERENCE TABLES

Small Order Charge: Orders with a combined Net price under \$1,000 will be subject to a Special Handling Charge of \$125 Net. One charge per order.



1333
1-1/4" laminate top. The edges are banded with solid vinyl "T" molding, with 1" radius at corners.



1344
1.25" solid vinyl flat T mold edge. High pressure laminate top standard with 1" radius corners. Available in a variety of colors



2400
1.25" x 1.25" square wood edge high pressure laminate, veneer, or Veneer Art top surface



2405
1-1/4" laminate top. The edges are banded with hardwood. No radius at corners.



3810
1.25" x 1.25" beveled wood edge high pressure laminate, veneer, or Veneer Art top surface



2600
1.75" x 2" squared wood edge high pressure laminate, veneer, or Veneer Art top surface



2605
1.75" X 2" full bullnose wood edge high pressure laminate, veneer, or Veneer Art top surface

STORM™



4720 Postformed
1-1/4" plastic laminate top. The front edge is sloped, reducing strain on the wrist. The side and rear edge are banded with rigid PVC molding. Modesty edge 1440



1300 / 1307 Bumper T-Mold
1-1/4" laminate top. The edges are banded with solid vinyl "T" molding, with 7/8" radius at corners. Modesty edge 1300



1333 / 1337 Eased T-Mold
1-1/4" laminate top. The edges are banded with solid vinyl "T" molding, with 1" radius at corners. Modesty edge 1300



4150 / 4157 Sloped Urethane
1-1/4" laminate top. The front urethane edge is sloped, reducing strain on the wrist. The sides and rear have a flat urethane edge. Modesty edge 1440



1340 / 1347 Reveal T-Mold
1-1/4" laminate top. The edges are banded with 5/16" solid vinyl "T" molding, with 7/8" radius at corners. Modesty edge 1300



1440 / 1447 Flat PVC
1-1/4" laminate top. The edges are banded with flat PVC molding. No radius at corners. Modesty edge 1440

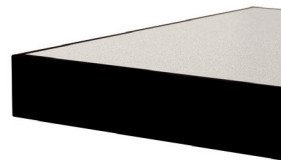

1444 / 1448 Flat PVC
1-3/4" laminate top. The edges are banded with flat PVC molding. No radius at corners. Modesty edge 1440



2405 / 2407 Wood Bullnose
1-1/4" laminate top. The edges are banded with hardwood. No radius at corners. Modesty edge Flat Wood Band



2323 / 2327 Wood Band
1-1/4" laminate top. The edges are banded with 1/4" hardwood. No radius at corners. Modesty edge Flat Wood Band



2344 / 2348 Wood Band
1-3/4" laminate top. The edges are banded with 1/4" hardwood. No radius at corners. Modesty edge Flat Wood Band



2420 / 2427 Wood Edge
1-1/4" laminate top. The edges are banded with hardwood. No radius at corners. Modesty edge Flat Wood Band

FALCON™

POWER SOLUTIONS WORKBOOK/PRICE LIST January 2017

DELIVERED TO ZONE 1, ADD + 4% DELIVERED TO ZONE 2



Interlink IQ Starter Unit

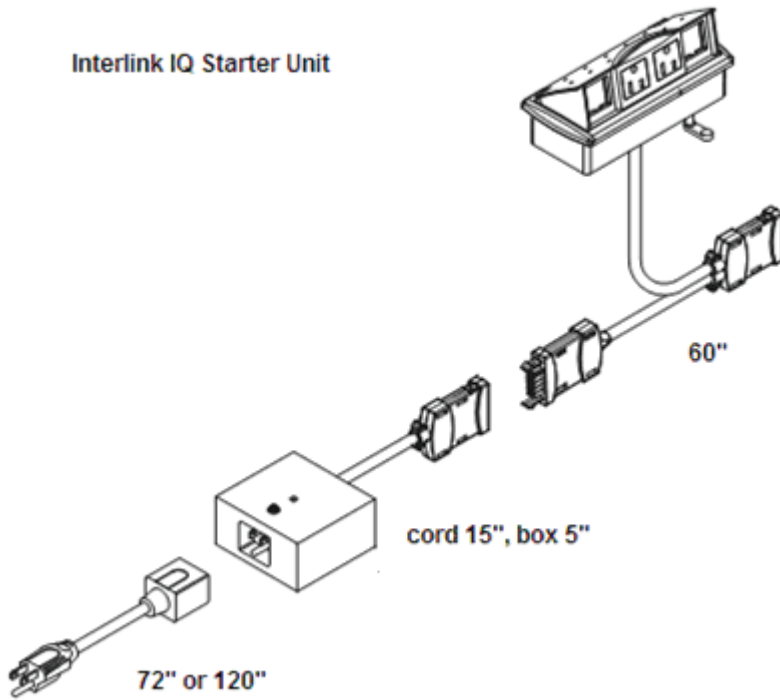

Interlink IQ Add on Unit

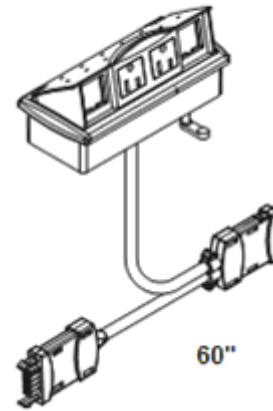

NON SEQUENTIAL POWER SYSTEM – 15 AMP SYSTEM RATING

The Non Sequential Power System is designed for use with most Falcon tables in training/classrooms where tables are reconfigured on a regular basis. This unit provides 15 amps of power in a flexible format. A single run can accommodate up to eight tables (60" long or less) with one miniport per table, or four tables with two miniports per table. Tables 72" or longer require two units per table. Additional table top access units available, contact your local sale representative or customer service for information.

- Up to 8 duplex non sequential devices
- Single Circuit Power
- 12 Amp System Rating
- 15 Amp Power Cord with 15 Amp over-current protection
- 40 Ft. Maximum Total Length
- Color: Black
- UL recognized

MIPT9IQ STARTER UNIT

Size	Price
72"	483
120"	506

MIPT9IQ ADD ON UNIT

Size	Price
60" only	186

Starter Link / Link #1

Add-On Link / Link #2 thru #8

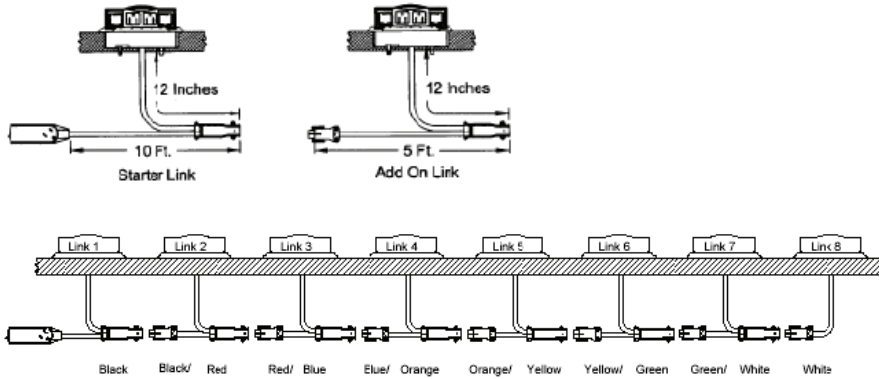

INTERLINK MINIPOINT – 15 AMP SYSTEM RATING

This system is used for basic work surface power needs, connecting table to table without the need of an electrician. It can be used on most Falcon connected tables that require affordable power from a single power source. Not appropriate for Syntech tables.

- Up to 8 duplex devices and must be connected in sequence
- Single Circuit Power
- 12 Amp System Rating
- 15 Amp Power Cord with 15 Amp over-current protection
- 40 Ft. Maximum Total Length
- Color: Black
- UL Recognized

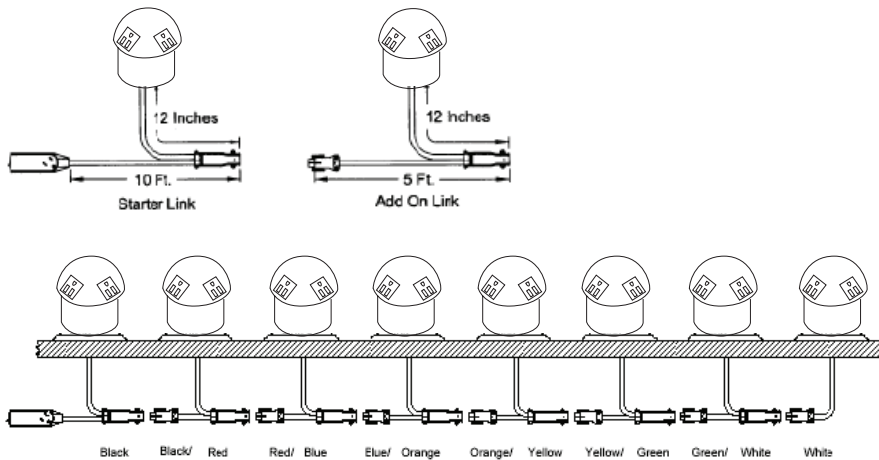

INTERLINK POWER SPHERE – 15 AMP SYSTEM RATING

This system is used for basic work surface power needs, connecting table to table without the need of an electrician. It can be used on most Falcon connected tables that require affordable power from a single power source. Not appropriate for Syntech tables.

Power/Communication Sphere (2) Simplex ~ (2) Data Ports

- Up to 8 duplex devices and must be connected in sequence
- Single Circuit Power
- 12 Amp System Rating
- 15 Amp Power Cord with 15 Amp over-current protection
- 40 Ft. Maximum Total Length
- Color: Black
- UL Recognized

Note: A single run can accommodate up to eight tables (60" long or less) with one miniport per table, or four tables with two miniports or power spheres per table. Tables 72" or longer require two units per table.

MIPT6

Starter Link	Connects to	Price
Link 1	Power Source	291
Link 2	Link 1	248
Link 3	Link 2	248
Link 4	Link 3	248
Link 5	Link 4	248
Link 6	Link 5	248
Link 7	Link 6	248
Link 8	Link 7	248

PS6

Starter Link	Connects to	Price
Link 1	Power Source	291
Link 2	Link 1	248
Link 3	Link 2	248
Link 4	Link 3	248
Link 5	Link 4	248
Link 6	Link 5	248
Link 7	Link 6	248
Link 8	Link 7	248

INTERCONNECT – (4) 20 AMP CIRCUIT POWER SYSTEM

Used for hard-wire power needs to connect table in longer, more permanent situations where an isolated circuit is needed. Can be used on any MATS shared leg table application. All power is accessible at the work surface and all cabling/ jumpers are clipped to underside of work surface. Licensed electrician is needed to connect to power source.

Interconnect System

8 wire, 4 circuit system
 20 amp per circuit
 Up to 13 units per circuit
 UL / CUL listed Manufactured Wiring System (UL 183)

IPT6S Starter Kit Includes:

- (2) Interports / BE08977-3-X-S-F04-16
- (1) Power Infeed / BE08180-3-MTLC-72
- (1) H Block / BE08299-3 (bottom row, left)
- (1) H Block Mounting Kit / BE01500 (bottom row, center)
- (3) Conduit clamps / BE01501 (bottom row, right)

IPT6DA Double Add On Kit Includes:

- (2) Interports / BE08977-3-X-S-F04-16
- (1) M/M Adjustable Jumper / BE08116-3-60
- (1) H Block / BE08299-3 (bottom row, left)
- (1) H Block Mounting Kit / BE01500 (bottom row, center)
- (4) Conduit clamp / BE01501 (bottom row, right)

IPT6SA Single Add On Kit Includes:

- (1) Interport / BE08977-3-X-S-F04-46
- (1) Conduit clamp / BE01501

IPT6

Model #	Description	Price
IPT6S	Starter Kit	533
IPT6DA	Double Add On Kit	504
IPT6SA	Single Add On Kit	208

IPT6S

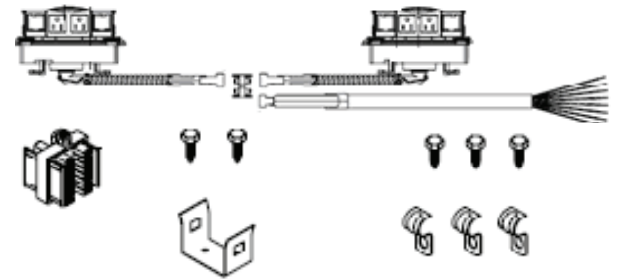

IPT6DA

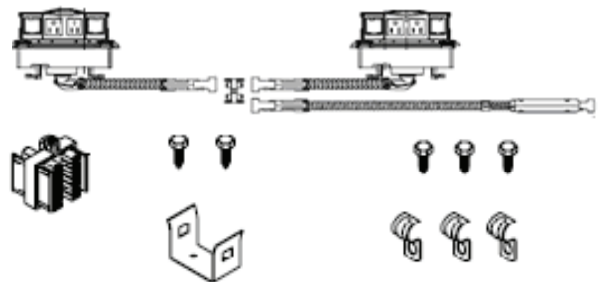

IPT6SA



X = circuit designation for Miniports. One Circuit (1, 2, 3, or 4) specified per unit. Circuit Designation does not change pricing

4-TRAC – (2) 20 AMP CIRCUIT POWER SYSTEM

Used for hard-wire power, to connect tables in longer, more permanent situations where an isolated circuit is not needed. Can be used on any Falcon MATS, Storm, or Syntech table application and all power is to be mounted to underside of work surface. Power is accessible, for plug in only, on underside of table and is accessed through grommets in the work surface or simply waterfall over edge to plug in. Licensed electrician is needed to connect power to the source.

- 4-Wires, 2 circuits, 20 Amps each (Circuit 1 and 2 only)
- 13 - Duplex receptacles per circuit, 26 duplex receptacles per power infeed maximum
- UL Listed as a Manufactured Wiring System

4-Trac Hard-wire Power Entry

- Includes (2) PVC Legway Wire Sleeves
- Must Specify Length
- Hard-wiring must be performed by a licensed electrician
- Plug in power entry SPEP1 simplifies system to single circuit



PD4 / PEH4

Model #	Description	Price
PD4-42	4-Trac 42" Table Kit	167
PD4-48	4-Trac 48" Table Kit	170
PD4-60	4-Trac 60" Table Kit	178
PD4-72	4-Trac 72" Table Kit	187
PEH4-1	4-Trac Hard-wire Power Entry	119

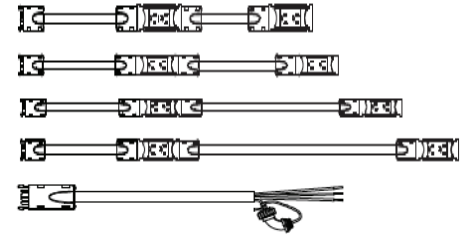

SYNTECH

Model #	Description	Kit Includes	Price
SEP42	42" table - Select Circuit 1 or Circuit 2	1 PD Unit & 1 PD Unit Bracket	51
SEP48	48" table - Select Circuit 1 or Circuit 2	1 PD Unit & 1 PD Unit Brackets	51
SEP54	54" table - Select Circuit 1 or Circuit 2	1 PD Unit & 1 PD Unit Bracket	51
SEP60	60" table - Select Circuit 1 or Circuit 2	2 PD Units, 2 PD Unit Brackets & 7" Jumper	97
SEP72	72" table - Select Circuit 1 or Circuit 2	2 PD Units, 2 PD Unit Brackets & 14" Jumper	100
SPEH1	Hard-wire for Syntech shared leg only		90
SPEP1	72" Length Power Entry Straight Plug for Syntech freestanding only		178

EXTRA

Model #	Description	Price
SJ48	48" Jumper for Syntech only	99
SJ54	54" Jumper for Syntech only	127
CC1	Clips	27

8-TRAC – (4) 20 AMP CIRCUIT SYSTEM

Used for hard-wire power which needs to connect tables in longer, more permanent situations, where an isolated circuit is needed. Can be used on most training/classroom table application with an enclosed wire management gallery. Designed to be installed attached to gallery or under surface mounting (depends on table series) but should be inside wire management gallery when possible. Not appropriate for Syntech tables.

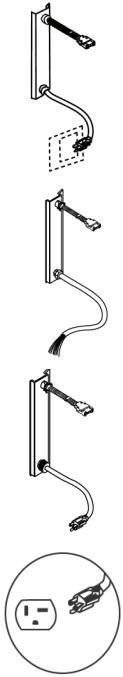

POWER ENTRY

Model #	Description	Price
PEQ1	Quick-Connect Power Entry for 29"H MATS freestanding Tables	339
PEQ2	Quick-Connect Power Entry for 27"H & 29"H MATS Shared Leg Tables - includes wall Rotating Power Entry	339
PEQ3	Quick-Connect Power Entry for 38"H MATS Shared Leg Tables - includes wall Rotating Power Entry. Wall/floor box requires installation by a licensed electrician.	339
PEH1	Hard-wire power entry (Universal) for 29"H MATS freestanding tables.	321
PEH2	Hard-wire Power Entry (Universal) for 27"H & 29"H MATS Shared leg tables	321
PEH3	Hard-wire Power Entry (Universal) for 38"H MATS Shared leg tables. 8 wire, 4 circuit, 80 amp available per power entry. Requires installation by a certified electrician. Cord length 6'0" standard.	321
PEP1	20-Amp Single Circuit Power Entry (Universal) for 29"H MATS freestanding tables - Circuit I only.	331
PEP2	20-Amp Single Circuit Power Entry (Universal) for 27"H & 29"H MATS shared leg - Circuit I only.	331
PEP3	20-Amp Single Circuit Power Entry (Universal) for 38"H MATS shared leg - Circuit I only.	331

ELECTRICAL POWER DISTRIBUTION

Single In-Line for MATS shared leg

Includes one duplex receptacle per junction block

Model #	Description	Price
PDES30	30" Table Power Distribution	115
PDES36	36" Table Power Distribution	167
PDES42	42" Table Power Distribution	204
PDES48	48" Table Power Distribution	213
PDESC48	48" Corner Table Power Distribution	262
PDES54	54" Table Power Distribution	221
PDES60	60" Table Power Distribution	227
PDES72	72" Table Power Distribution	243

Double Back-to-Back for MATS shared leg

Includes two duplex receptacles per junction block

Model #	Description	Price
PDEB30	30" Table Power Distribution	136
PDEB36	36" Table Power Distribution	212
PDEB42	42" Table Power Distribution	246
PDEB48	48" Table Power Distribution	256
PDEBC48	48" Corner Table Power Distribution	262
PDEB54	54" Table Power Distribution	265
PDEB60	60" Table Power Distribution	271
PDEB72	72" Table Power Distribution	287

Note: Circuit I standard when using PEP1/2/3. Specify Circuits: I, II, III, IV when using PEH1/2/3 or PEQ1/2/3

POWER DISTRIBUTION UNITS - INSTALLED IN WIRE MODESTY GALLERY

Model #	Description	Price
PD42	42" Table Includes: 1 single junction block, 1 placement bracket, 1 receptacle	81
PD48	48" Table - Includes: 2 single junction blocks, 1 placement bracket, 2 receptacles	116
PD60	60" Table - Includes: 2 single junction blocks, 1 placement bracket, 2 receptacles	170
PD72	72" Table - Includes: 2 single junction blocks, 1 placement bracket, 2 receptacles	186

Note: Circuit I standard when using PEP1. Specify Circuits; I, II, III, IV when using PEH1

EXTRA

Model #	Description	Price
RCPT1	Duplex Receptacle (must specify circuits I, II, III, IV)	27
J30	30" Jumper - MATS shared leg	140
J54	54" Jumper - MATS freestanding	164
J72	72" Jumper - MATS freestanding	186

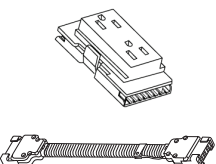
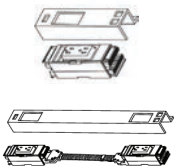

ACCESSORIES

COMMUNICATION KITS

Model #	Description	Price
DC1	Down-Leg Communication Channel	35
CMM1	Communications Kit - RJ45 8-Pin CAT 5	90
CMM2	Communications Kit - RJ11 6-Pin CAT 3	57
CMM3	Face Plate & Adapter Kit for Customer's Own Communication	12

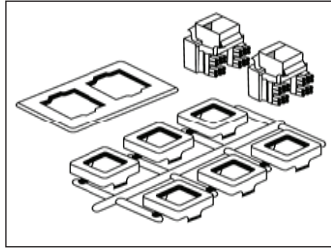

CMM1 w/face plate, adapter kit and two RJ45 8 pin couplers CAT 5 Amp #406372-2. Requires hardwiring by customer.

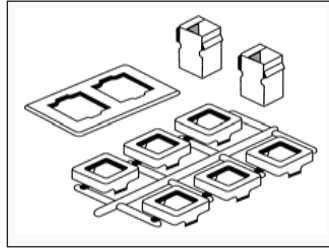

CMM2 w/face plate, adapter kit and two RJ11 6 pin couplers CAT 3 Amp #555050-1

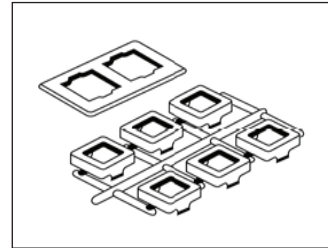

CMM3 w/face plate and adapter kit. Adapts to most standard industry couplers. See chart below

Notes:

- Face plates install in standard knockouts.

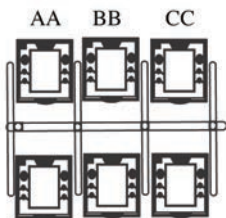







Adapter	Type of Coupler/Jack
AA	AT&T/Lucent Technologies Category 5
BB	Amp Category 5/Panduit Category 5
CC	Amp Category 3/Krone Category 5

Adapters accommodate couplers and jacks by the following manufacturers:

- Amp** 1-800-522-6752
- Leviton** 1-800-722-2082
- Lucent** 1-800-427-7127
- Krone** 1-800-775-5766
- Panduit** 1-800-777-3300

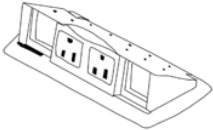
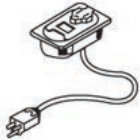
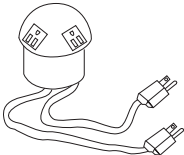
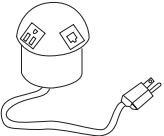
ACCESSORIES

Simple options that bring the electrical connection to the work surface top for easy access and plug in without needing to find plug/power source.

Model #	Description	Price
 GRM2	Grommet Includes: grommet and cover, installed. Color: Black. Size 2 3/8" diameter Grommet will be located 8 1/2" in from the right short edge and 2 1/2" from the back edge. You may also specify location on your order.	87
 GRM3	Grommet Single Includes: grommet and cover, installed. Color: Black. Size: 2 1/4" x 4" Grommet will be located 8 1/2" in from the right short edge and 2 1/2" from the back edge. You may also specify location on your order.	87
 MIPT2	Miniport (door stays open when in use) 2 Simplexes. 6 feet, 15 amp cord. 2 Voice/Data ports. Color: Black. Specify location.	240
 GRM8	Flush Mount Grommet Includes: grommet and 1 simplex installed. Size: 2" x 4". Color: Black. Grommet will be located 8 1/2" in from the right end and 2 1/2" from the back edge. Specify location.	98
 PS1	Power Sphere - Power Includes: 4 simplexes, 15 amp, two 6' cords, installed. Also available with data only ports. Size: 3 1/2" diameter. Color: Black. Grommet will be centered and installed 2 7/8" from back edge in center. Specify location.	259
 PS2	Power Sphere - Power & Communication Includes: 2 simplexes, 15 amp, two 6' cords, 2 spaces (customer's own communication), installed. Size: 3 1/2" diameter. Color: Black or Silver. Grommet will be centered and installed 2 7/8" from back edge in center. Specify location.	298
 PET	Temporary Power Strip 15 amp, 4 simplex receptacles. 10' cord. Color: Black	275
 EXP / MHO	Power/Data Center (single sided unit, five ports) Includes: 2 simplexes, 15 amp, 3 data ports, 72" power cord Standard with single side, double sided also available Available from two to eight ports per side Finish: clear anodized aluminum. Specify location.	411
 AAP	Adapter Bracket (Upcharge to EXP price) Available on EXP unit only. Adapter plate provides configuration options for audio and visual components	49 upcharge to EXP price

Note: Cut Out only, add \$45 to price of table.
 Must supply template and placement information with the order.

ACCESSORIES



Model #	Description	Price
EXP2	Power/Data Center (double sided unit, five ports) Includes: 2 simplexes, 15 amp, 1 active USB hub, 1 modular data opening, 72" power cord. Standard with single side, double sided also available. Available from two to eight ports per side. Contact customer service or your sales representative for additional information. Finish: clear anodized aluminum. Specify location.	806
PASSIVE USB-A JACK	PASSIVE USB-B JACK Includes: 48" cord	46 upcharge to EXP2 price
PASSIVE USB-B JACK	PASSIVE USB-A JACK Includes: 48" cord	46 upcharge to EXP2 price
GLB-65	GLENBEIGH CONTEMPORARY Two position. Available in: satin nickel plated or powdercoat, silver, black or parchment (white). Specify location. Specify Contemporary on order	366 Plated 265 Powdercoat
GLB-65	GLENBEIGH TRADITIONAL Two position. Available in: satin nickel plated or powdercoat, silver, black or parchment (white). Specify location. specify Traditional on order	366 Plated 265 Powdercoat
POWER CONSOLE	POWER CONSOLE Console may be added between two wallbenches, or at the end of a unit, adds 8" Standard is laminated, may be upholstered (call for quote) Add your electrical option price to console price for the complete unit price Price includes cut out per electrical option selected Shown here with GLB-65 power option	649
ECLIPSE	ECLIPSE Includes: 3 standard outlets standard, or 2 outlets 1 USB 2-Port Charger upcharge Available in: soft touch black, white, orange, or green plastic, standard Cord: 72" standard, 120" \$10 upcharge	264 3 Power 338 2 Power, 1 USB
HEMISPHERE	HEMISPHERE Includes: 3 standard outlets standard, or 2 outlets 1 USB 2-Port Charger upcharge Available in: soft touch black, white, orange, or green plastic, standard Cord: 72" standard, 120" \$10 upcharge	174 3 Power 239 2 Power, 1 USB
AXIL Z	AXIL Z Includes: 2 power, 1 USB Charger and 1 Open Data Available in: black and white painted finishes	597

Note: Cut Out only, add \$43 to price of table.
Must supply template and placement information with the order.

ACCESSORIES

Simple options that bring the electrical connection to the work surface top for easy access and plug in without needing to find plug/power source.

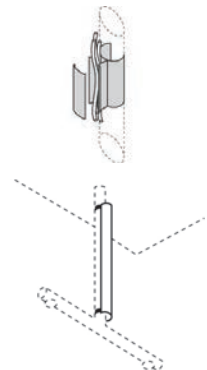
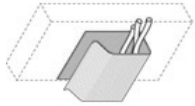

Model #	Description	Price
WM2	J channel under table wire manager Black Plastic	WM-2-F 48" 77
		WM-2-G 60" 86
		WM-2-H 72" 91
MESH WIRE BAG	Mesh Wire Bag Under table horizontal wire management, Kit includes: sheerweave mesh, 2 velcro loops, 2 velcro hooks	24" 118
		9" 57
HAMPTON LEG	Hampton Leg (Vertical Wire Manager) Priced per set, includes: three standard 2" columns, one 2' wire mgr column, metal carpet glides. Also available with 3" columns, call for quote Also available as column only to add to table base, priced each, add to table base price	6502 Grd1&2, Std ht 473
		6502 Grd5, Std ht 667
		SU6502 Grd1&2, Stand-Up ht 744
		SU6502 Grd5, Stand-Up ht 937
WM6B	Clip on Leg Wireway Used for Folio tables only. Finish black.	75
WL27	Aluminum Legway Wire Manager Powdercoat finish to match leg, not available in polished chrome Use on Storm tables only.	86
NODE	Node Includes: 2 Power/ 0 Open or 1 Power/ 1 USB 2-Port Charger Available in: Satin nickel plated, parchment powercoat (\$47), silver powercoat (\$47), dark bronze plated, midnight powercoat (\$47). Standard 72" cord, 120" \$10 upcharge.	269 2 Power 339 1 Power, 1 USB

ACCESSORIES

Simple options that bring the electrical connection to the work surface top for easy access and plug in without needing to find plug/power source.



Model #	Description	Price
MINITAP	MiniTap Includes: 1 power/ 1 USB 2-Port Charger Available in: Gloss black, gloss white, silver powdercoat. Standard 72" cord, 120" \$10 upcharge.	Face Mount 316
		Hidden Mount 390
		Clamp Mount 329
MINITAP	MiniTap Includes: 2 power/ 0 open Available in: Gloss black, gloss white, silver powdercoat. Standard 72" cord, 120" \$10 upcharge.	Face Mount 245
		Hidden Mount 317
		Clamp Mount 256
PEPPER	Grommet Round or Square Includes: Simplex only. Available in: Black, white, blue, orange, spring green, honey, navy, poppy, storm, dusk. 72" cord standard, 120" Upcharge. (\$10)	90
SALT	Grommet Round or Square Includes: USB 2-Port Charger. Available in: Black, white, blue, orange, spring green, honey, navy, poppy, storm, dusk. 72" cord standard, 120" Upcharge. (\$10)	217
FLX	FLX Power Management Table Bases Allows power to run down the center of a pedestal table. Available for: 200, 400, 600, 800, 900, 2700, 4400, 6900, and Syntech 25OVX Bases. Upcharge to table base price. Power unit sold separately. Power units available for FLX: Node, PS2 Power Sphere, MIPT2 Miniport, EXP/MHO Power/Data Center.	358 upcharge

ELECTRICAL WORKSHEET

We have a variety of power solutions appropriate for any of your power requirements. Please take a moment to evaluate your project and complete the following check list. It will help determine which power solution best fits your needs. After you have answered these questions, contact your sales representative, or customer service representative, who will assist you with the specific details for adding the power option to your table order.

My client is powering more than one table (Y/N)

- _____ Our plan calls for less than 16 users per row
- _____ I need data brought into the tables
- _____ I need power at the top surface
- _____ I need power accessible below the table for CPU's to plug into
- _____ The room is permanent and will not be reconfigured
- _____ The room will have bolt down tables
- _____ Power is currently available in the wall
- _____ Power is currently available in the floor
- _____ New construction, power can be located anywhere
- _____ What is the desired table length
- _____ How many users per table

SOLUTIONS

I. Simple Power

Simple power is defined as a 15 amp plug that is inserted into a standard outlet. Each electrical component in the table would plug directly into the floor or wall. This power is commonly used with conference tables or very small training rooms.

II. Table Top Daisy Chain Power

This power allows you run rows of tables in a training room. Up to 16 users (2 per unit) can generally be provided with power from one access point. If there are more than 16 users, additional access points must be designated. The type of power can be applied using one of the following options.

a. Interlink

- 12 amp system rating with 15 amp power cord
- Up to 8 duplexes devices such as Miniports
- Meets UL 962

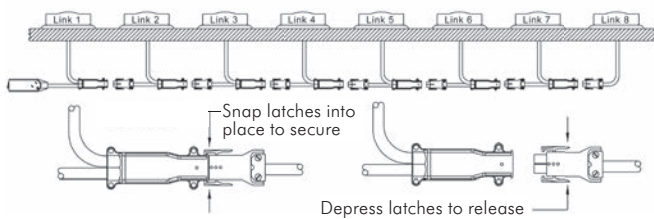

b. Nonsequential

- 12 amp system rating with 15 amp power cord
- Up to 8 duplexes devices such as Miniports
- Meets UL 962

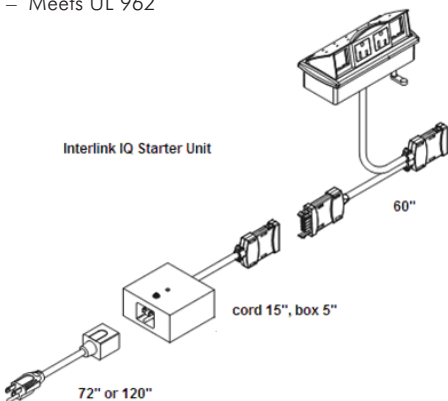

What will be plugged into each table:

- Number of Computers
- Number of Monitors
- Number of Printers or other equipment

Does the building have 15 amp power available (Y/N)

Does the building have 20 amp power available (Y/N)

Note: Falcon's standard power options do not meet Chicago or New York codes, contact your sales representative for assistance.

c. Interconnect

- 8-wire, 4-circuit system or 4-wire 2-circuit system depending on power need.
- 20 amp per circuit rating
- UL 183.
- Must be hard wired to the building or utilize quick connect.
- Building must be wired for 20 amp rating.

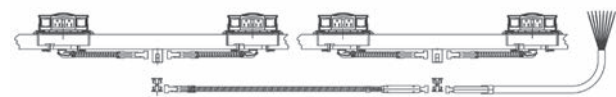

III. Fully Integrated Power within the Wire Manager and Table Top

This solution allows for computer rooms to power a CPU, monitor, printer, etc. from underneath the table surface as well as power other ancillary equipment from the top surface. It allows for long runs of power with the ability to segregate for clean circuits.

- 20 amp single circuit solution that utilizes a 20 amp plug.
- 2 circuit system that is rated at 20 amps per circuit (requires hardwiring to the building)
- 4 circuit system that is rated at 20 amps per circuit (requires hardwiring to the building)
- Building must be wired for 20 amp rating
- UL1286 Rated



Information is for planning purpose only. Contact a licensed electrician to ensure required building codes are met.

IV. Small Order Charge

Orders with a combined Net price under \$1,000 will be subject to a Special Handling Charge of \$125 Net. One charge per order.

ELECTRICAL WORKSHEET

CLIENT INFORMATION

Client _____
 Project Number _____
 Department _____
 Floor Number _____
 Zone _____

Date _____
 By _____
 Copy _____
 Designer
 Electrician
 Facility Manager

INSTALLING ELECTRICIAN TO COMPLETE:

Breaker Panel # _____
 Breaker Numbers _____
 Circuit one _____
 Circuit two _____
 Circuit three _____
 Circuit four _____

CIRCUITS POWERED:

Circuit one
 Circuit two
 Circuit three
 Circuit four

ELECTRICAL CONTRACTOR INFORMATION

For each circuit, please list each piece of equipment and corresponding amperage below.

**CIRCUIT I
COMMON GROUND**

Equipment	Amps
Amperage Total	
Available Amps	

**CIRCUIT II
COMMON GROUND**

Equipment	Amps
Amperage Total	
Available Amps	

**CIRCUIT III
COMMON GROUND**

Equipment	Amps
Amperage Total	
Available Amps	

**CIRCUIT IV
ISOLATED GROUND**

Equipment	Amps
Amperage Total	
Available Amps	

GLOSSARY OF ELECTRICAL TERMS

Amps, Amperage

Unit of electrical current. Considered to be the volume of electricity flowing through a wire (compare to voltage, wattage).

Chicago and New York Codes

Falcon's standard power options do not meet these requirements, contact your sales representative for additional information.

Circuit

A complete electrical path that leads from a power source, through an electrical device, and back to the source.

Conduit

Metal housing that is required by most codes for the protection of power-carrying wires. May either be a rigid casing or flexible tubing.

Dedicated Circuit

One circuit that is set aside, by nature of the system, for a specific use. For example, the four-wire 20 amp power cord has a dedicated ground wire which cannot be accessed by other circuits because terminals are polarized.

Downrated Circuit

A circuit that is under load continuously for three or more hours. To protect wires and terminals from overheating under this load, the circuit rating is lowered from the maximum 20 amps to 16 amps.

Hard-wire

An electrical connection made by stripping insulation from individual wires and physically joining them for a permanent installation. The hard-wire entry option must be performed by a licensed electrician who will connect the proper wires to support multiple option features.

Isolated Ground

Power in a specific circuit that has been protected from interference created in other circuits.

NEC, National Electrical Code

This comprehensive set of electrical codes developed by the National Fire Protection Association is available by writing:

National Fire Protection Association
Battermarch Park
Quincy, MA 02269

UL, Underwriter's Laboratories

Created by insurance underwriters as a nationally recognized testing laboratory for evaluating commonly insured products. Information may be obtained by writing:

Underwriter's Laboratories
333 Pfingsten Road
North Brooke, IL 60062

Volt, Voltage

Unit of electrical pressure in a circuit. Compare this to amperage which is the volume of current.

Watt, Wattage

A measure of electrical power. Equal to electrical pressure (voltage) multiplied by volume (amperage) in a circuit (ie: 120 volts multiplied by 1.5 amps equals 180 watts).

The Falcon Advantage	3	Pin Leg Base Square	24	SPECTRA TABLES	40
How to Order	4	Pin Leg Base Round	24	Stationary Tables	41
Base and Table Finishes	5	Freestanding Options	25	SP3F Square	41
Table Top Options	6	Portable and Freestanding Options	26	SP3F Rectangle	41
FOLIO TABLES	7	Lecture Features and Benefits	27	SP3F Trapezoid	42
Folding Tables	8	Shared Leg Stationary Tables	28	SP3F Truncated Triangle	42
24FT Rectangle	8	41S Freestanding/Starter	28	SP3F Quarter Round	42
24FT Round	8	42A Add On	28	SP3F Half Round	43
24FT Racetrack	9	41S Corner Chamfer	29	SP3F Round	43
24FL Lightweight Rectangle	9	42A Corner Chamfer	29	Folding Tables	44
24FA Folding Modesty Panel	9	In-Line Screen Grouping	30	SP5F Square	44
Stationary Tables	10	41LD Freestanding Starter	30	SP5F Rectangle	44
24TT Rectangle	10	42LD Add On	30	SP5F Trapezoid	45
24TT Round	10	Back-to-Back Screen Grouping	31	SP5F Half Round	45
24TT Square	10	41BD Freestanding/Starter	31	SP5F Round	45
24TM Fixed Modesty Panel	11	42BD Add On	31	Training Stationary Tables	46
Stationary Shapes	12	Corner Screen Grouping	32	SP3FA Square	46
24TS Rectangle	12	41LC Freestanding Starter	32	SP3FA Rectangle	46
24TS Trapezoid	12	42LC Add On	32	SP3FA Trapezoid	47
24TS Quarter Round	13	Back-to-Back Corner Screen Grouping	32	SP3FA Truncated Triangle	47
24TS Half Round	13	41S Freestanding/Starter	32	SP3FA Quarter Round	48
24TS Crescent	13	42A Add On	32	SP3FA Half Round	48
Folio Table Specifications	14	Starter and Add on Modesty Panels	33	Training Folding Tables	49
Folio Table Options	15	MODP2	33	SP5FA Square	49
Folio Table Finishes	16	MODP2C	33	SP5FA Rectangle	49
MATS TABLES	17	MODPS	33	SP5FA Trapezoid	50
Portable Lightweight Folding	19	MODPSC	33	SP5FA Half Round	50
Rectangle	19	MODPA	33	Spectra Specifications	51
Trapezoid	20	MODPAC	33	Spectra Finishes	53
Half Round	20	ADA Compliance	33	STORM TABLES	54
Quarter Circle Crescent	20	WCK49	33	Stationary Tables	56
Portable Shapes and Configurations	21	MATS Project Planner and Checklist	35	ST3TC Clamp On Modesty Panel	56
Freestanding Stationary	22	MATS Ordering Information	36	ST3CC Clamp on Modesty Panel	56
Rectangle	22	MATS Power Solutions	37	ST3TA Folding Modesty Panel	56
Trapezoid	23	Edges and Colors	38	ST3CA Folding Modesty Panel	56
Half Round	23	Starter and Add on Modesty Panels	33	ST3T Rectangular	57
Quarter Circle Crescent	23	MODP2	33	ST3C Rectangular	57
Freestanding Pedestal & Pin Leg	24	MODP2C	33	ST3X Square Pedestal Base	58
Pedestal Base Square	24	MODPS	33	ST3X Rectangular Pedestal Base	58
Pedestal Base Round	24	MODPSC	33	ST3X Round	58
Pedestal Base Rectangle	24	MODPA	33	ST3T Racetrack	59
		MODPAC	33	ST3T Boatshape	59
		ADA Compliance	33	ST3T Trapezoid	60
		WCK49	33	ST3T Quarter Round	60

ST3T Half Round	60	SYNTECH TABLES	79	65CV-CT Curve Rectangle	95
ST3T Crescent	60	250CS Starter	80	65CV-CT Curve Conference	96
ST6TN/ST6CN Rectangle	61	250CA Add On	80	65CV-WA Curve Wave	96
ST6TNM/ST6CNM Modesty Panel	61	250CSM Starter w/ Modesty	81	Conference & Meeting Tables	97
Flip Top Tables	61	250CAM Add on w/ Modesty	81	J91CT Round	97
ST6X Square	62	25NS/25NC Flip/Nesting Tables	82	J91CT Square	97
ST6X Rectangle	62	25NSM/25NCM Flip/Nesting Tables	82	J91CT Rectangular	97
ST6X Round	62	Meeting & Conference Tables	82	J91CT Racetrack	98
ST6T Rectangle	63	25SS Rectangle	82	J91CT Boatshape	98
ST6TC Clamp on Modesty Panel	63	25SS Racetrack	83	J11CT Round	99
ST6T Trapezoid	64	25MC Media Conference	83	J11CT Square	99
ST6T Half Round	64	Multi-Surface Meeting Tables	83	J11CT Racetrack	100
ST6T Crescent	64	25NW Network Pod	83	J11CT Boatshape	100
ST6TB Rectangle	65	25CCE Curved End	84	24CT Rectangular	101
ST6TB Trapezoid	65	25CSE Straight End	84	24CT Round	101
ST6TB Half Round	65	25CCR Crescent Connector	84	24CT Square	101
ST5T Square	66	25CHR Half Round	84	24CT Racetrack	102
ST5T Rectangle	66	25C45 Connector- 45°	84	24CT Boatshape	102
Light Weight Folding	67	25C90 Connector- 90°	84	31 CT Round	103
ST5T Light Weight Rectangle	67	25CW Wedge Connector	84	31 CT Square	103
ST5TA Light Weight Folding Modesty Panel	68	Syntech Features, Options, and Finishes	85	31 CT Rectangular	103
ST5CR Light Weight Removable Modesty Panel	68	Syntech Edge Profiles	86	31 CT Racetrack	104
Folding Tables	69	SYMEYTIS TABLES	87	31 CT Boatshape	104
ST5CR Removable Modesty Panel	69	Stationary Tables	88	51 CT Round	105
ST5TA Folding Modesty Panel	69	36S Starter	88	51 CT Square	105
ST5T Round	69	36 A Add on	88	51 CT Rectangular	105
ST5T Racetrack	70	Modesty Tables	89	51 CT Racetrack	106
ST5T Trapezoid	70	36NSM and NCM	89	51 CT Boatshape	106
ST5T Half Round	70	Krystalcast Modesty Panel	89	POWER SOLUTIONS	111
ST5T Crescent	70	36 NS and NC	89	MIPTI9Q Starter Unit	112
Bridges	71	36 TD teachers desk	90	MIPT9IQ Add On Unit	112
STB Bridges	71	Active Learning Tables	90	MIPT6	113
STSB Square Bridges	71	36POD	90	PS6	113
Adjustable Height	72	400 Series	91	IPT6	114
ST7X Round	72	CONFERENCE TABLES	92	IPT6S	114
ST7X Square	72	Single Surface Meeting Tables	93	IPT6DA	114
ST7T Rectangle	72	25SS Syntech Rectangle	94	IPT6SA	114
ST7TS Split Top	72	25SS Syntech Racetrack	94	PD4	115
Storm Specifications	74	25MC Syntech Media Conference	94	PEH4	115
Storm Options	76	65CV-CT Curve Round	95	Syntech Extra	115
Storm Finishes	78	65CV-CT Curve Square	95	Power Entry	116
				PEQ1	116
				PEQ2	116
				PEQ3	116
				PEH1	116

PEH2	116	PS1	118
PEH3	116	PS2	118
PEP1	116	PET	118
PEP2	116	EXP	118
PEP3	116	MHO	118
Electrical Power Distribution	116	AAP	118
PDES30	116	EXP2	119
PDES36	116	Passive USB-A Jack	119
PDES42	116	Passive USB-B Jack	119
PDES48	116	GLB-65 Contemporary	119
PDESC48	116	GLB-65 Traditional	119
PDES54	116	Power Console	119
PDES60	116	Eclipse	119
PDES72	116	Hemisphere	119
PDEB30	116	Axil Z	119
PDEB36	116	PDC1	120
PDEB42	116	PDC2	120
PDEB48	116	PDC4	120
PDEBC48	116	WM2	120
PDEB54	116	WM4A	120
PDEB60	116	Mesh Wire Bag	120
PDEB72	116	Hampton Leg	120
Power Distribution Units 116		WM6B	120
PD42	116	WL27	120
PD48	116	Electrical Worksheet	122
PD60	116	Glossary of Electrical Terms	124
PD72	116	Index	125
Extra	116		
RCPT1	116		
J30	116		
J54	116		
J72	116		
Communication Kits	117		
DC1	117		
CMM1	117		
CMM2	117		
CMM3	117		
Accessories	118		
GRM2	118		
GRM3	118		
MIPT2	118		
GRM8	118		